

DCO7 accessories

The following items can be used with your DCO7. For further information please see the order form, or visit the Dyson website at www.dyson.com.au or www.dyson.co.nz



Mini Turbobrush

Rotating brushbar powered by constant airflow improves pick-up of pet hairs and other fibres. Ideal for cleaning in confined areas, e.g. car, stairs, upholstery.

*item not approved by British Allergy Foundation.



Zorb carpet-cleaning powder (750g)*

Millions of tiny sponges absorb dirt from the carpet, keeping new carpets looking new with none of the drawbacks of wet cleaning.

Important

- This appliance is not intended for use by young children or infirm persons without supervision.
- Young children should be supervised to ensure they do not play with the appliance.
- Check that your electricity supply corresponds to that shown on the rating plate. The appliance must only be used as rated.
- If the supply cable of the appliance is damaged, disconnect the appliance from the socket outlet immediately. The supply cable must be replaced by the manufacturer or its service agent or a similarly qualified person in order to avoid a hazard.
- Do not use the cleaner if the cable or plug are damaged or if the cleaner has been damaged, dropped or has come into contact with water or any other liquid. In these cases, contact the Helpline.
- When vacuuming, certain carpets may generate small static charges in the clear bin. These are entirely harmless and are not associated with the mains supply. To minimise any effect from this, do not put your hand or insert any object into the clear bin unless you have first emptied it and rinsed it out with cold water.
- Do not continue to use the cleaner if any part appears to be faulty, missing or damaged.
- Do not carry out any maintenance work other than that shown in this manual or advised by the Helpline and do not put anything into the openings or moving parts of the machine.
- Only use parts produced or recommended by Dyson; failure to do so could invalidate your guarantee.

European conformity information:

a sample of this product has been tested and found to be in conformity with the following European Directives: 73/23/EEC Low Voltage (Safety) Directive, 93/68/EEC CE Marking Directive and 89/336/EEC EMC Directive.

For your safety

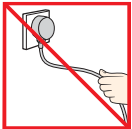

Do not pull on supply cable.

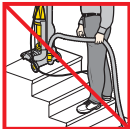

Do not use cleaner above you on stairs.



Do not use cleaner near naked flames.

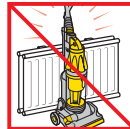

Do not leave cleaner near heat sources.

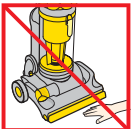

Do not place hands under brushbar when in use.

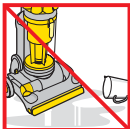

Do not use cleaner to pick up water or any other liquid.

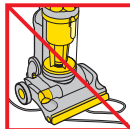

Do not run over supply cable.

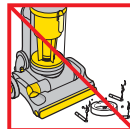

Do not use cleaner to pick up burning objects of any kind.

Dyson Customer Care

Every new Dyson domestic vacuum cleaner has a 2 year guarantee.

If you have a query about your Dyson, call the Dyson Customer Helpline with your serial number and details of where/when you bought the cleaner.

Most queries can be solved over the phone by one of our factory-trained Helpline staff.

If your cleaner needs attention from our engineers, we aim to have it repaired and tested within 3-5 working days.

Your serial number can be found on your rating plate which is underneath the machine beneath the wheels.



Note your serial number for future reference:



AU 1800 239766

Unit 8, 7-11 Parraweena Road, Taren Point, Sydney NSW 2229.

NZ 0800 397 667

Avery Robinson Ltd, 151D Marua Road, Ellerslie, Auckland.

Visit the Dyson website for product information and to order accessories and spares.

www.dyson.com.au
www.dyson.co.nz

This product is protected by the following Intellectual Property Rights:

Patent/Patent Application Nos:

EP1066115, EP0489565, EP0636338,
EP0800359, EP0800360, EP1098586,
EP1119281, EP1119282, EP1121043,
AU32024/01/EP01904105.2, US07/555,953,
US6425931, US09/806,918, US6442791,
US09/806,930, CA 2313177, CA 2325953,
AU30432/99, AU744298, AU744408,
AU744362, AU637272, AU697029,
AU14947/99, AU30432/99, AU50510/99,
AU30432/99, EP1066115, US6425931,
AU744408, EP1119282, US09/806,918,
AU744298, EP1119281, US6442791,
AU744362, EP1121043, US09/806,930,
GB 2342283, GB 2342282, WO 02/067742,
WO 02/067753, WO 02/067751, GB 0104662.2,
GB 0109390.5, GB 2372468, WO 02/067750,
GB 2372469, WO 02/067756, GB 2374305,
PCT/G802/01378, GB 0109402.8, GB 2372435,
WO 02/067757, GB 2372470, WO 02/067754,
WO 02/067752, GB 2372436.

Design registrations: GB 2099793, AU146419, US29/147,074

Equivalent patents, registered designs and applications exist in other countries. Equivalente patente, registriertes Design und Patentanmeldungen bestehen auch in anderen Ländern. Des brevets équivalents, ainsi que des designs et des applications déposés, existent dans d'autres pays.



User guide

Please read this guide carefully before use.



dyson

DCO7

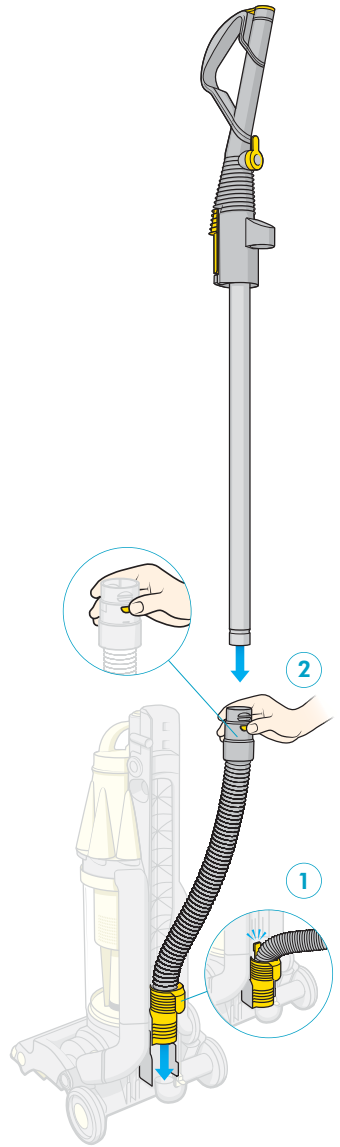
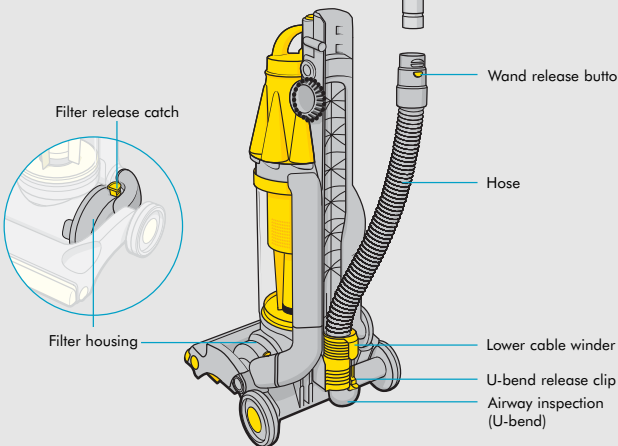
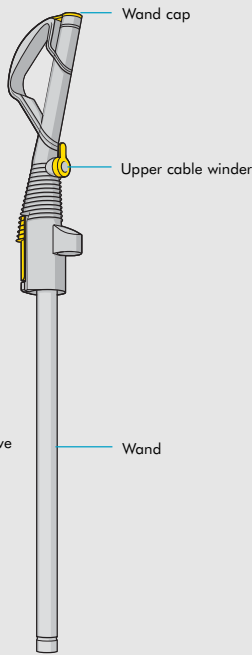
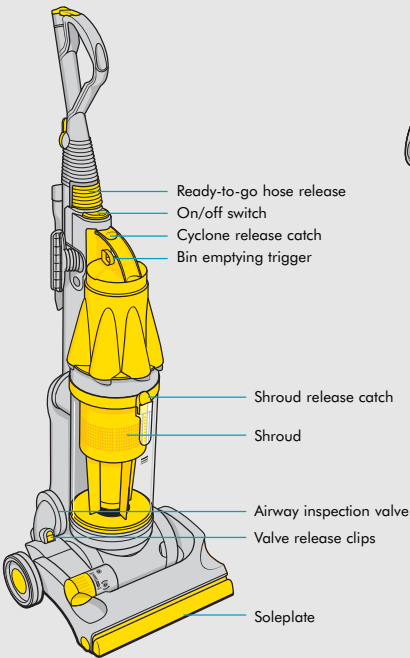
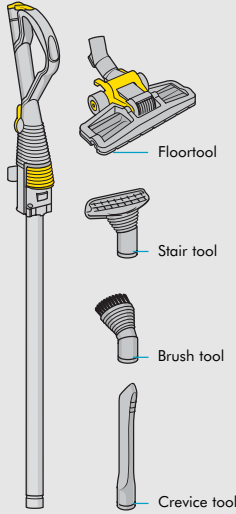
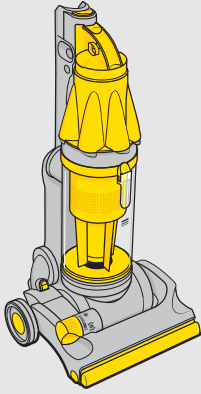
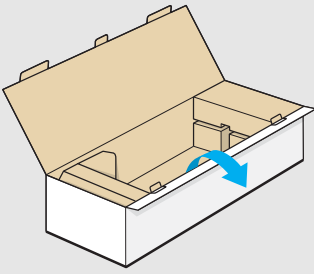

Assembling DCO7

- 1 Place the machine on its side, remove the u-bend. Slide hose into runners at back of machine and push down until it clicks. Click the u-bend back into place.
- 2 Press wand release button and slide wand down into hose.

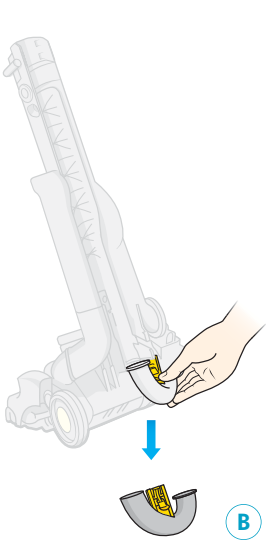

Tilt machine forward and slide out U-bend airway inspection **B**. Check inside for blockages.

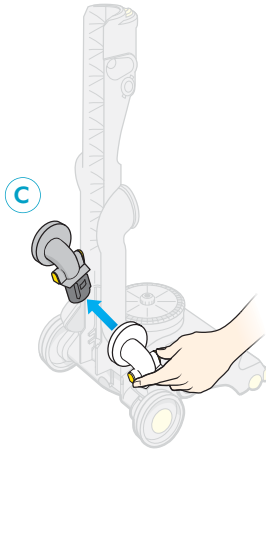

Squeeze valve release catches to remove airway inspection valve **C**. Check inside for blockages.

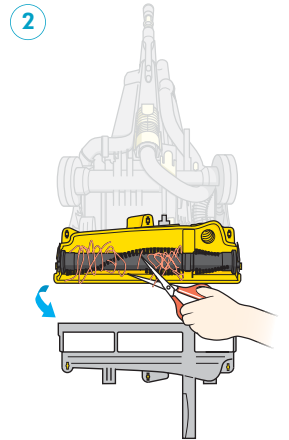
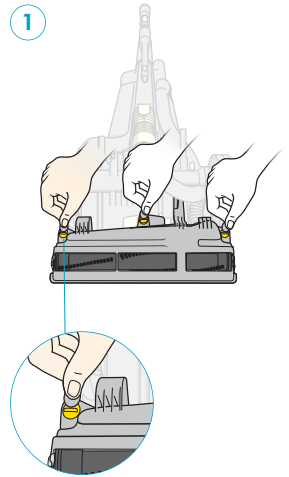

Lie cleaner on its front.

- 1** Undo coloured fasteners using a coin and remove soleplate.
- 2** Clear the brushbar obstruction, carefully cutting away any threads.

Replace soleplate and tighten fasteners.

Turn power off and unplug before starting to clear any blockages.

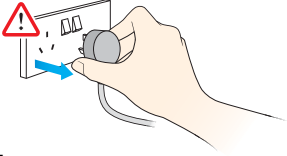

Important

Please note that clearing blockages is not covered by your cleaner's guarantee.

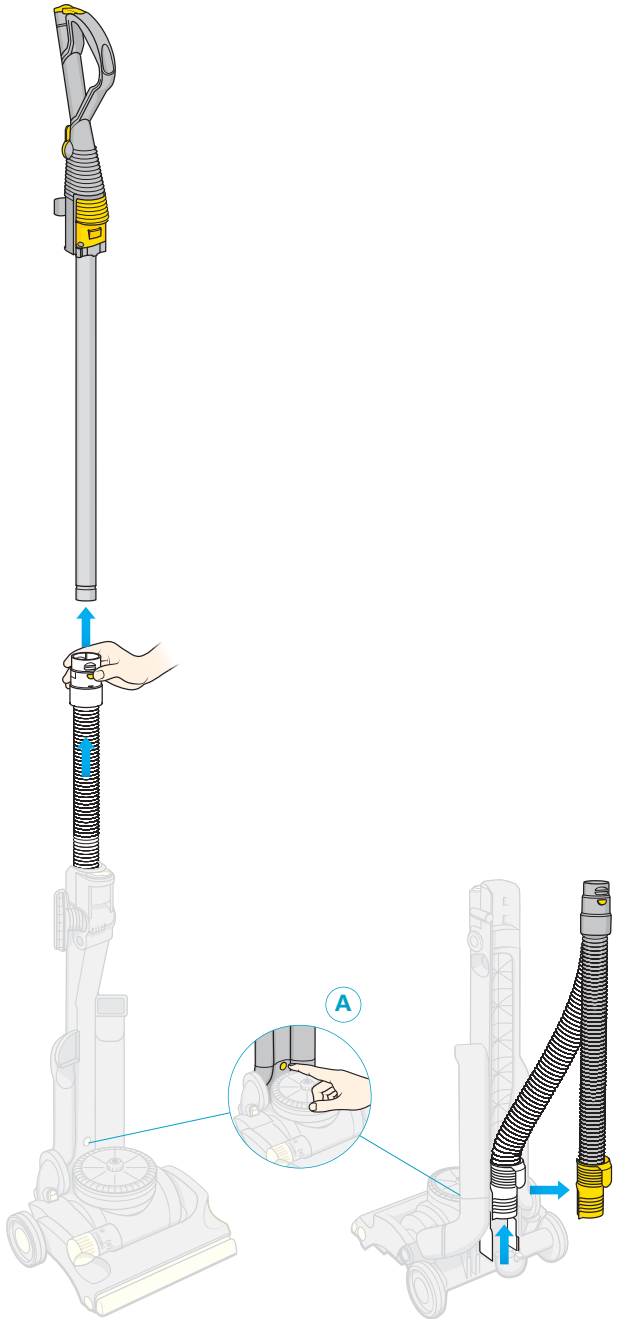
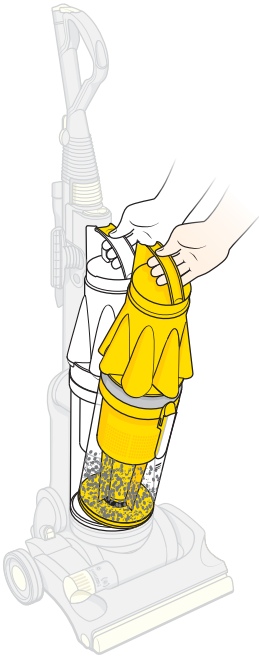
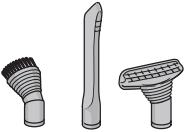

Where to look for blockages

Check that tools are clear of blockages.

Remove bin assembly from machine.

NB Should any part of the machine become blocked it may overheat and stop due to the thermal cut-out being triggered. Unplug from mains and leave to cool down for at least 30 minutes.

Remove wand and check inside for blockages.

Press hose release button **A** from front of machine and slide hose out with lower cable winder from rear.

Check inside hose for blockages.

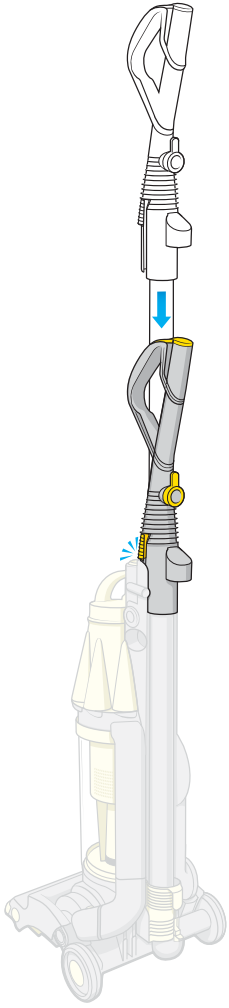

Slot wand into top of machine and click into place.

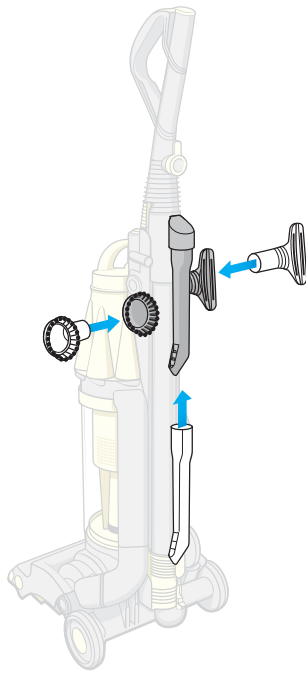

Click tools into place.

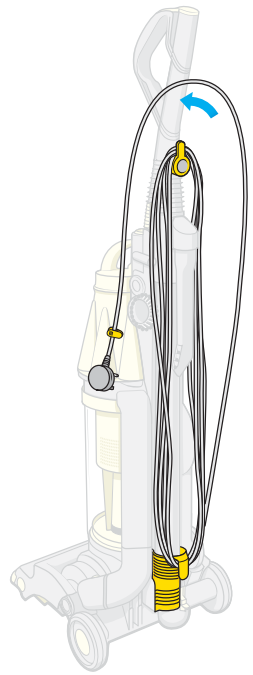

Wind cable anti-clockwise around cable winder and secure with clip.

 Ensure hair and loose clothing are kept clear of wand cap/brushbar when machine is switched on.

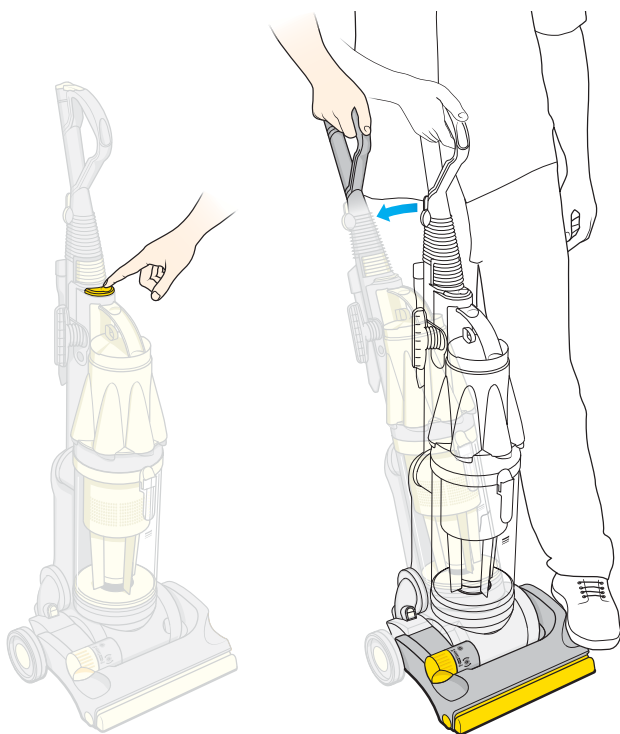

Using your DCO7

Plug in at mains and press on/off switch.

To start vacuuming, push cleaner head down with foot and pull handle towards you.

Anti-jam brushbar

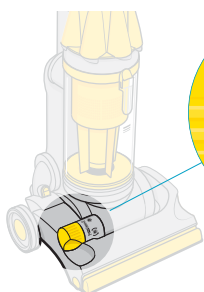

1 Manual brush off
for delicate rugs and floors.

2 Brush off
when upright.

3 Auto brush on
for normal cleaning.

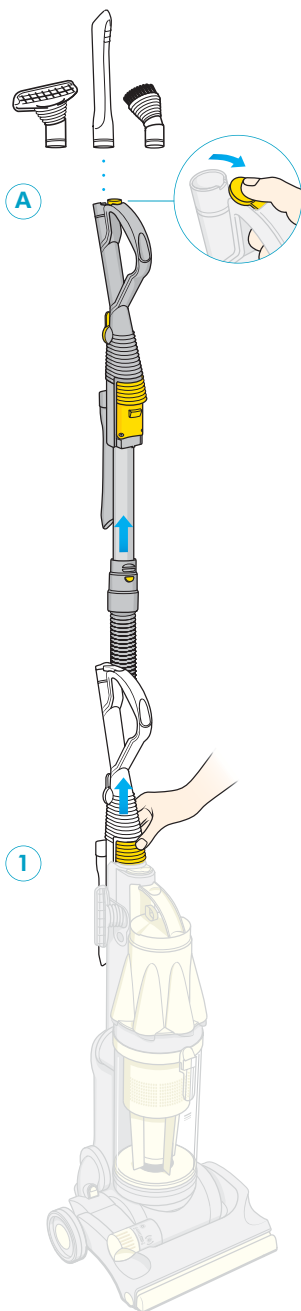

Using the tools

Ensure machine is in upright position before using tools.

Press wand release catch **1** to release ready-to-go hose and slide wand to end of hose.

A Wand mode

Slide back wand cap and place tools directly on to wand handle.

NB You can twist the brush and stair tool heads to make cleaning easier.

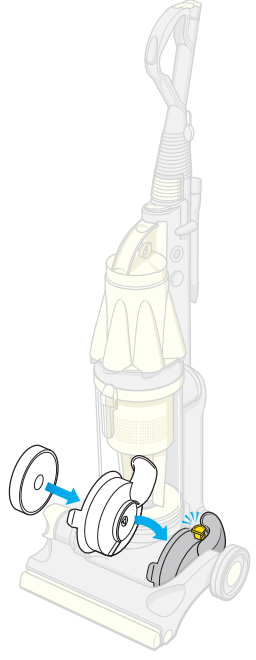
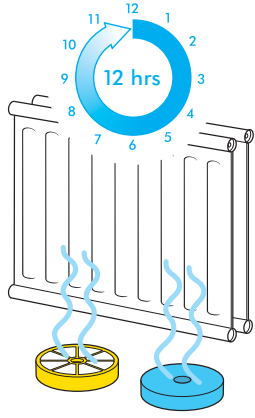
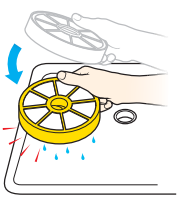
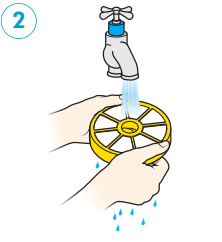
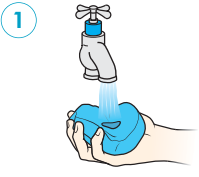

Repeat steps **1** and **2** until water runs clear.

Allow 12 hours for filter to dry. Make sure it is completely dry before replacing in machine.

Replace in filter housing and click back into machine.



Turn power off and unplug before removing filter.

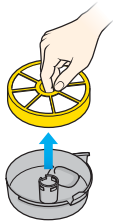
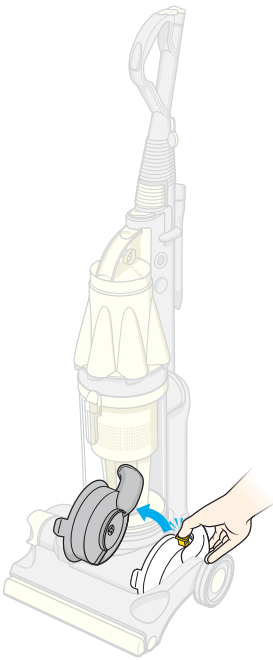
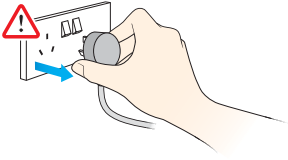

Washing the lifetime pre-motor filter

Press filter release catch and remove filter housing from machine.

Filter should be washed every six months. Circle your two washes.

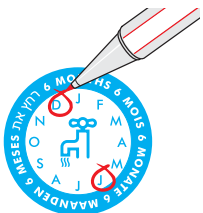

Remove filter from housing.

Only blue foam and yellow cage should be washed.



Wash in cold water only.



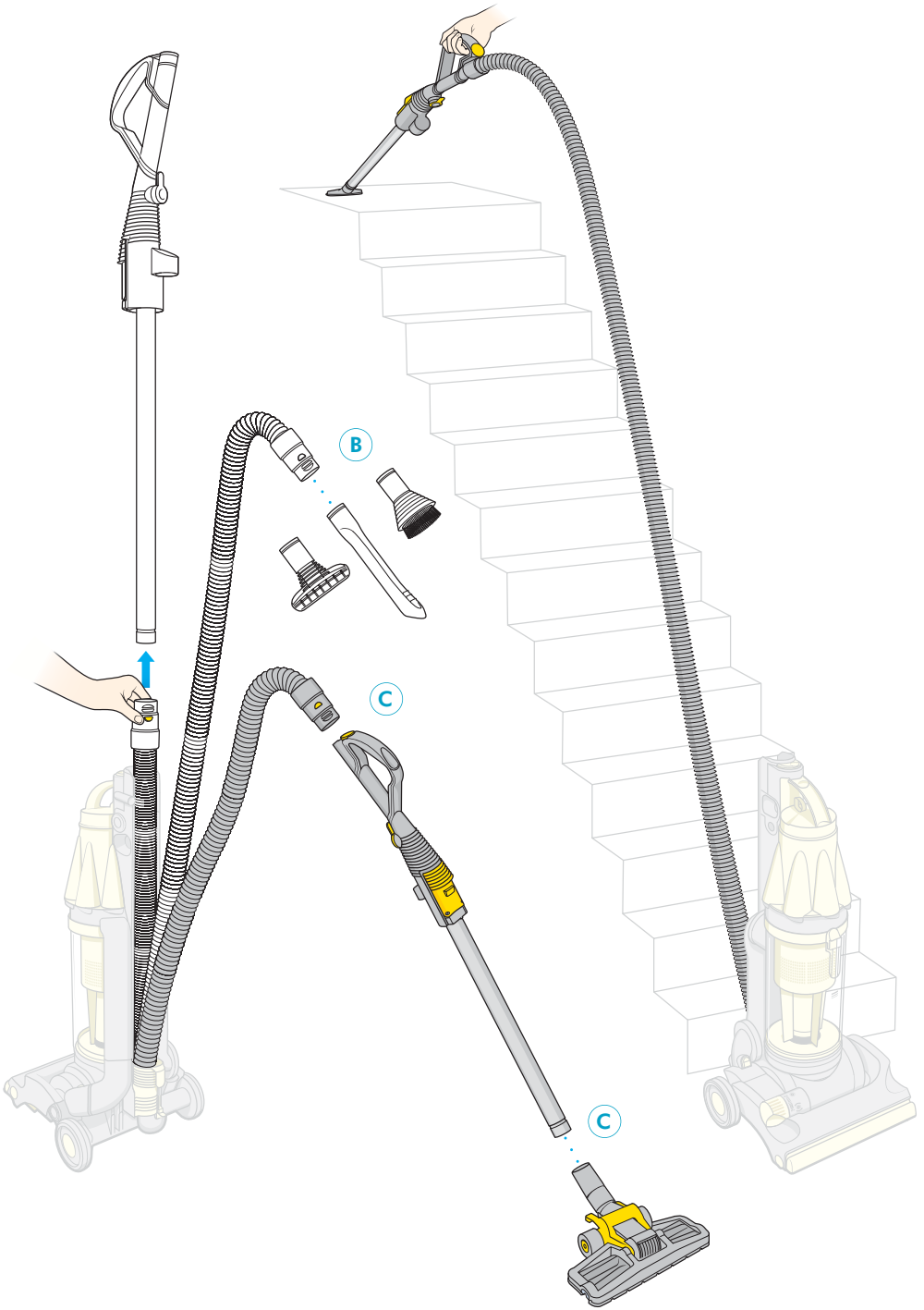

Press wand release button and remove wand.

B Hose mode

Fit tools directly on end of hose. For confined spaces such as car cleaning.

Reverse wand by inserting wand handle into hose.

C Reversed wand mode

Fix tools or floortool on to end of wand. For hard to reach areas.



Ensure wand cap is closed, unless using with tools.

Stair cleaning

Always work with the machine at the bottom of the stairs.



Powerful suction can cause the hose to 'pull back' in use – please take extra care when cleaning stairs.

Turn power off and unplug before emptying the bin.

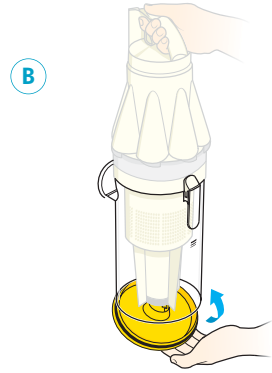
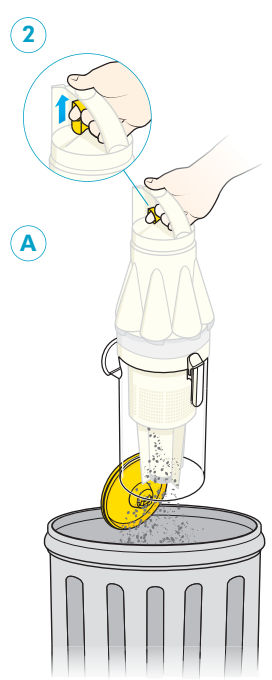
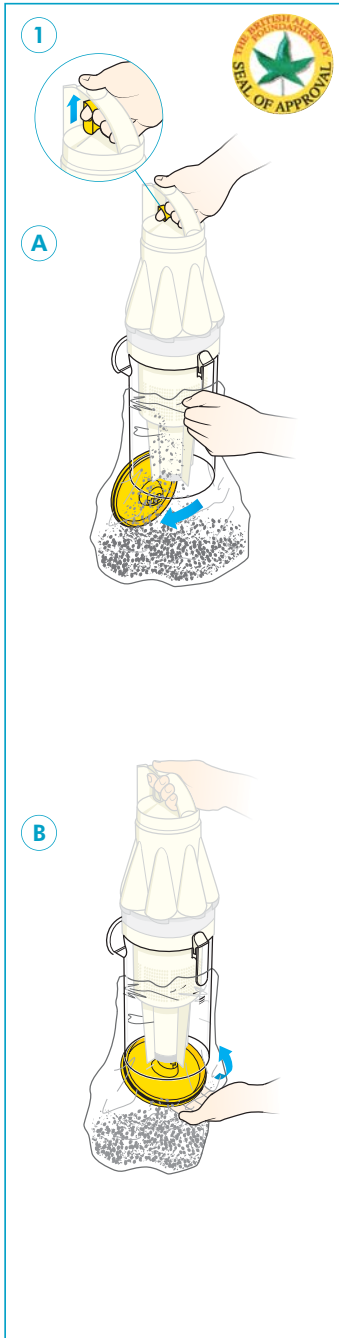
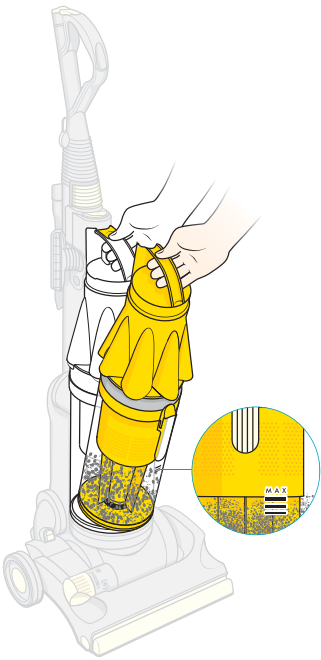
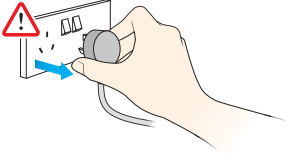

Emptying the clear bin™

Important

Bin must be emptied when dust reaches **MAX** mark.

Press cyclone release catch with thumb to remove bin assembly.

Option 1 (recommended for asthma/allergy sufferers).

Wipe outside of clear bin with a damp cloth before emptying.

A Place bin in bag and pull bin emptying trigger to release dust into bag.

B Let dust settle, then close bin base securely before removing from bag. Seal bag and replace bin assembly on to machine.

Option 2

A Empty directly into dustbin.

B Ensure bin base is closed securely and replace bin assembly on to machine.



The British Allergy Foundation considers that this product may in proper use reduce exposure to both House Dust Mite (Der p 1) and Cat Allergen (Fel d 1). It is strongly recommended that a sensitive person should take care when emptying the clear bin™. We recommend the manufacturers' emptying instructions should be strictly followed.

Assessment carried out by BAF indicate that an individual's exposure can be reduced but this does not mean that an individual's allergic symptoms will necessarily diminish. BAF's opinion applies only to the products and allergen stated. The product should be used only for its intended purpose and strictly in accordance with the manufacturers' instructions at all times.

Exposure to allergen can be dangerous. If you believe that you may suffer from an allergy you should seek medical advice. The British Allergy Foundation is a national charity (Charity Reg. No. 1003726) founded in 1991 with the aim of improving awareness, prevention and treatment of allergy.

The Foundation continually strives to help sufferers to help themselves, often seeking to avoid or reduce exposure to relevant allergens. The Seal of Approval scheme forms a part of this initiative.

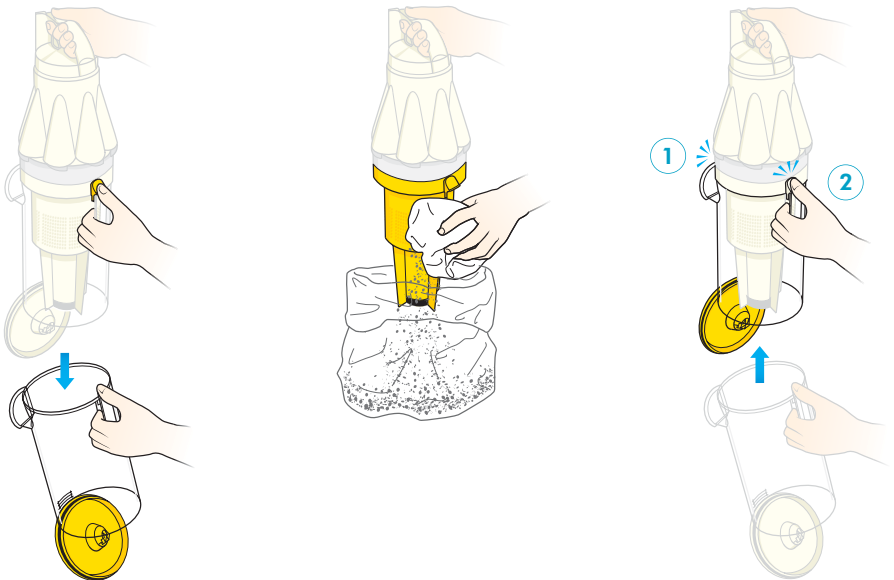

Cleaning the shroud (if necessary)

Ensure bin is empty and bin base is open. Then press shroud release catch to remove bin.

Clean shroud with a cloth or dry brush to remove fluff and debris.

To replace bin, first click rear bin catch **1** and then front bin release catch **2** into place.

Ensure bin base is closed securely and replace bin assembly on to machine.

Optional



- You may rinse the clear bin with water.
- Do not use detergents.
- Do not immerse the whole cleaner in water.
- Ensure it is completely dry before replacing.