

dyson

Range brochure

The vacuum cleaner that doesn't lose suction.



Dyson supporting

**ASTHMA
FOUNDATIONS**
AUSTRALIA



“2 Tier Radial™ cyclones are the latest development of our patented cyclone technology.

By making the cyclones smaller, the centrifugal forces inside are increased. This means we can capture even more microscopic dust in the bin, the very dust which makes others lose suction.”

James Dyson

JAMES DYSON
Inventor of cyclone vacuum technology























Dyson engineered and tested

Over 1,000 Dyson engineers and scientists in Britain, Singapore and Malaysia are dedicated to inventing and improving Dyson machines. They are drawn from a broad spectrum of disciplines: Electrical engineering; fluid dynamics; prototyping; electronics; design; testing; separation systems; robotics; software; materials; motors; aerodynamics; microbiology; mechanical engineering; acoustics; compliance; hardware. And others. Every member of the Dyson Research, Design and Development team is an expert in their field. They take great pride in ensuring Dyson machines outperform others and that they're built to last.

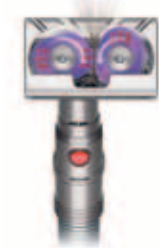

Over 35 years of invention

<p>Ballbarrow</p> 	<p>Dual Cyclone™ technology</p> 	<p>DC02</p> 	<p>Radix Cyclone™ technology</p> 	<p>Ball™ technology</p> 	<p>Dyson Airblade™ hand dryer</p>    	<p>Radix Cyclone™ technology + intermediary cyclone</p> 	<p>Dyson digital motor</p> 
<p>1974</p> <p>While renovating, James designs the Ballbarrow. A wheelbarrow with a load-spreading ball that stops it sinking into the mud.</p>	<p>1993</p> <p>Dual Cyclone™ technology and DC01, the first vacuum with no loss of suction.</p>	<p>1995</p> <p>Dyson cyclone technology is developed to fit the shape of a barrel vacuum.</p>	<p>2001</p> <p>Dyson develops Radix Cyclone™ technology. Dust and dirt is now captured from the airflow using eight cyclones.</p>	<p>2005</p> <p>No more wheels. DC15 rides on a ball to steer without the awkward moves of conventional vacuums.</p>	<p>2006</p> <p>The Dyson Airblade™ hand dryer uses 640km/h sheets of air, scraping water from hands in just 10 seconds.</p>	<p>2008</p> <p>Improved cyclone technology includes an intermediary cyclone, to capture even more microscopic dust than any other cyclone.</p>	<p>2009</p> <p>The Dyson digital motor is smaller than conventional motors, yet it spins up to 104,000rpm – five times faster than a racing car engine.</p>
<p>DC31 Handheld</p>  	<p>Air Multiplier™ technology</p>  	<p>Dyson Digital Slim™ vacuum</p>  	<p>Dyson Ball™ vacuum</p> 	<p>Dyson Hot+Cool™ fan heater</p> 	<p>Mini tangle-free turbine tool</p> 	<p>2 Tier Radial™ cyclones</p> 	
<p>2009</p> <p>The next generation of Dyson handhelds, powered by Dyson digital motor.</p>	<p>2009</p> <p>The Dyson Air Multiplier™ fan with no blades. Air is amplified, giving an uninterrupted stream of smooth air.</p>	<p>2010</p> <p>The Dyson Digital Slim™ vacuum – portable cleaning power with no loss suction. Up top, down below and in-between.</p>	<p>2011</p> <p>Turns on the spot. The only barrel vacuum with a central steering mechanism – for greater control.</p>	<p>2011</p> <p>The Dyson Hot+Cool™ fan heater utilises Air Multiplier™ technology, making it the fastest to heat the room evenly.</p>	<p>2012</p> <p>The only turbine tool that doesn't tangle. Counter-rotating heads with brushes remove hair and dirt.</p>	<p>2012</p> <p>Two tiers of cyclones work in parallel to increase airflow and generate high centrifugal forces removing more microscopic dust and dirt.</p>	

The Dyson Airblade™ hand dryer was awarded the Carbon Reduction Label from the Carbon Trust and Planet Ark for the product's life cycle measurement and communication of total greenhouse gas emissions released, along with a commitment to further reduce these emissions in the next two years. The Good Design™ Logo is the independent symbol of good design. It represents that the design has been assessed by an independent panel of Australian and international design experts who recommend that Good Design Australia endorse it as an example of good design. The Design Award™ Logo and the Design Mark™ Logo are independent symbols of design excellence. They represent that the design has been assessed by an independent panel of Australian and international design experts who recommend that Good Design Australia endorse it as an example of design excellence.

Other vacuum cleaners lose suction



Bagless vacuum cleaners lose suction.

Although they might look similar to one another, many other bagless vacuum cleaners have inefficient cyclones. They capture less dirt than others so rely on filters to trap it instead. Just like bags, these disposable filters clog during use causing suction to drop.



Bagged vacuum cleaners can lose suction too.

James Dyson developed vacuum cyclone technology because bagged vacuum cleaners lose suction. When you use them, pores in the bag clog with dust causing suction to drop.

Dyson cyclone technology doesn't lose suction



With a Dyson vacuum cleaner there's no loss of suction.

Dyson vacuum cleaners don't have bags and don't rely on filters. Dyson cyclone technology generates forces up to 360,000G to separate even microscopic particles from the airflow. So there's no loss of suction.

Choosing the right Dyson vacuum cleaner

Here's a few things to consider when choosing a new Dyson vacuum cleaner:

Type of clean

- For the main clean, choose a barrel or upright vacuum that best suits your house size
- For quick, in-between cleans, a handstick is ideal
- For spot cleans, choose a handheld



Ease of use

- Ball™ technology turns on the spot without the awkward moves
- Selected Dyson models feature brush bar control at the handle
- All Dyson models excluding Handhelds feature wands for high reach cleaning

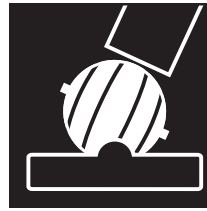

Type of floor

- Different heads are designed for improved pick-up on different surfaces
- A triggerhead or motorised head provides high pick-up on carpets
- A hard floor tool improves pick-up on hard floors and tiles
- A floor tool with carbon fibre filaments removes fine dust from hard floors



Size of house

- A full size vacuum is best suited to family homes
- For villas or apartments, a medium size vacuum is ideal
- In small studios or one bedroom flats, choose a compact vacuum



Pet hair removal

- Dyson's triggerhead or motorised models are best for homes with pets
- Selected machines include extra tools to remove stubborn hair from carpets
- Consider the Groom tool accessory for mess-free grooming of your dog



Allergy sufferers

- All Dyson uprights and barrels are accepted by the National Asthma Council Australia
- Dyson cyclones can capture particles down to 0.5 microns – including pollen mould and bacteria
- Dyson Allergy models have a mattress tool to remove dust mite faeces



BARRELS

Large – for family homes

Medium/small – for villas, apartments, studios and one bedroom flats



DC
39



DC
23



DC
29



DC
47

NEW

UPRIGHTS

Large – for family homes

Medium – for villas and apartments

Medium/small – for villas, apartments, studios and one bedroom flats



DC
41



DC
33



DC
40



DC
50

NEW

HANDHELDS

For spot cleans

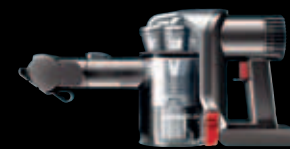

DC
34

HANDSTICKS

For in-between cleans



DC
44



DC
35

NEW

2 Tier Radial™ cyclones

Two tiers of cyclones work in parallel to generate high centrifugal forces to separate more microscopic dust than any other vacuum. Because more dust is extracted from the airflow there's no loss of suction.

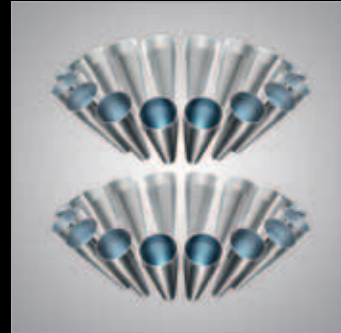

Finite element analysis
Reduces weight without compromising robustness.

Cyclone gaskets
The airtight seals within the cyclone assembly are made from materials designed to maintain high pressure differentials.

Self-inflating seal
Maintains pressure difference in cyclone chambers.

Inner cyclones
A symmetrical array of smaller inner cyclones generate centrifugal forces, extracting microscopic particles down to 0.5 microns in size, including mould spores and bacteria.

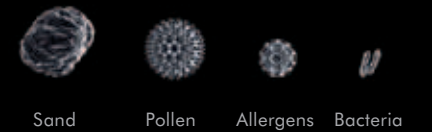

Vortex fingers
Guide air from inner cyclones, reducing turbulence and noise.

Shroud
The design means the outer cyclone captures debris allowing refinement of the inner cyclones to remove fine dust.



Dust and fluff

Outer cyclone
Dirty air is spun around a vertical axis, generating centrifugal forces that fling larger debris and hair from the airflow into the bin.



Hair and dirt

DC47 cyclone technology shown.



1993

Dual Cyclone™ technology
Developed for use in the first vacuum cleaner that doesn't lose suction.



2001

Radix Cyclone™ technology
By replacing one large cyclone with several smaller ones, Dyson engineers were able to increase airflow, therefore creating greater suction power and higher centrifugal forces to capture more dust and dirt.



2008

Radix Cyclone™ technology + intermediary cyclone
Improved cyclone technology that includes an intermediary cyclone (positioned between the outer and inner cyclones) to capture even more microscopic dust as small as 0.5 microns.



2011

Radial Cyclone™ technology
Remodelled airflows maximise suction power. Reconfigured air channels and improved flow efficiency reduce turbulence and preserve air pressure.

DC 47 multi floor

Two tiers of cyclones capture more microscopic dust.

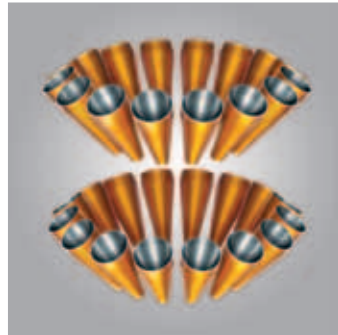

2 Tier Radial™ cyclones

Two tiers of cyclones work in parallel to increase airflow and capture more microscopic dust.



Turbine head with carbon fibre brushes

Air-powered turbine spins the brush bar. Anti-static carbon fibre brushes clean hard floors. Rotating nylon brushes remove more dirt from carpets.

Also included:

Combination accessory tool

Reaches further and has softer bristles for improved spot cleaning and gentle dusting.



Stair tool

Removes dirt and dust from corners and against vertical edges of stairs.



Velour bumper

Protects furniture and walls from bumps.



Approved by the National Asthma Council Australia.

*Whole machine HEPA filtration tested according to ASTM F1977.

Suction release trigger

Reduces suction so you can clean curtains, upholstery or rugs without them sticking to the cleaner.

Swivel cuff

Prevents hose from twisting during use.

Captures allergens, expels cleaner air

Dyson cyclones can capture particles down to 0.5 microns – including pollen, mould and bacteria.

HEPA filtration*

Ideal for allergy sufferers. Captures microscopic allergens as small as pollen and mould.

Tough, durable construction

Made from the strongest materials available to withstand bumps.

Lightweight adjustable wand

Adjust to the length you need.

Articulating cleaner head

Pivots 180° without losing floor contact.

V-Ball™ technology

Steers smoothly. No more awkward moves.

Self-adjusting sole plate

Maintains optimum contact from floor to floor.

Velour strip

Reduces air leaks to maintain suction.

Detachable handle

Attach tools directly to the handle or hose to clean awkward places.

Clear bin

Made from tough polycarbonate. Lets you see when it needs emptying.

Hygienic bin emptying

Just push the button to release the dirt.

Ball™ technology

Turns on the spot. The only barrel vacuum cleaner with a central steering mechanism – for greater control.



A Dyson Ball™ vacuum cleans without awkward moves.

2 Tier Radial™ cyclones

Smooth cable rewind

Cable rewind system has increased torque, so it's faster and less likely to catch on obstacles.

Lightweight robust chassis

Light to carry and body weight of approximately 4kg.

Articulating cuff

Spring-loaded to absorb sudden movement and help follow the user.

Low centre of gravity

The balanced arrangement and low motor position provide a low centre of gravity – maximising stability.

Axle bearings

Bearings in the axle reduce friction, enabling the ball to rotate smoothly.

DC50 multi floor

Concentrated technology.
Performance of a full-sized upright.



Advanced cleaner head technology
Self-adjusting motorised cleaner head for optimal contact on all floor types. Carbon fibre filaments remove fine dust from hard floors.



2 Tier Radial™ cyclones
Two tiers of cyclones work in parallel to increase airflow and capture more microscopic dust.

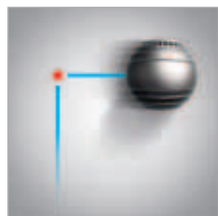

Ball™ technology – turns on the spot
Manoeuvres easily around furniture, obstacles and into difficult places.



Mini Flat Out™ head
Compact and low profile for easy cleaning under very low furniture.



Pedal-free automatic recline mechanism
Simply recline and go.

Approved by the National Asthma Council Australia.

*Whole machine HEPA filtration tested according to ASTM F1977.



Instant release wand
For cleaning stairs and hard to reach places. Intuitive release and docking. There are no separate parts to assemble.

Concentrated technology
Picks up as much as a full-size Dyson upright. Ideal for smaller homes.

Shrinks to store away
The handle compresses to 1/3 of its height, so you can store it in small spaces.

Fingertip controls
To turn the motorised brush bar off for delicate floors and rugs.

Lightweight and durable
Engineered materials are selected for their strength and durability. Weighs just 5.4kg.

Hygienic one-touch bin emptying
Just push the button, no need to touch the dirt.

HEPA filtration*
Ideal for allergy sufferers. Captures microscopic allergens as small as pollen and mould.

Captures allergens, expels cleaner air
Dyson cyclones can capture particles down to 0.5 microns – including pollen, mould and bacteria.

On-board tool storage
Combination accessory tool and stair tool are stored on the machine so they're always on hand.

Carbon fibre filaments
Remove fine dust from hard floors.

Self-adjusting cleaner head
For optimal contact on all floor types.

Technology in the cleaner head

The DC50 cleaner head has been engineered for increased dirt pick-up on all floor types. Four key technologies combine to make it our most advanced cleaner head technology to date.



Carbon fibre brush bar for hard floors
The brush bar has ultra-fine anti-static carbon fibre filaments to remove fine dust from hard floors. And on carpets stiff nylon bristles remove ground-in dirt.

Self-adjusting cleaner head
Cleaner head self-adjusts across all floor types. No fiddly dials or bending down to make adjustments.

Continuous contact brush bar
Dyson's first upright vacuum without rug strips on the cleaner head. This ensures the brush bar has full coverage of the surface it's cleaning.

In-line drive
The motor has been engineered to sit inside the brush bar. This means that more of the energy generated by the motor is transferred directly to the brush bar.



Conventional cleaner heads
The problem with most conventional cleaner heads is that they can leave fine dust on hard floors.

Dyson motorised head with carbon fibre brush bar
Carbon fibre filaments reduce static build up, removing fine dust from hard floors.

dyson ball

No loss of suction.
No awkward moves.

Radial Cyclone™ technology
Remodelled airflows maximise suction.



Ball™ technology
Turns on the spot. The only barrel vacuum cleaner with a central steering mechanism – for greater control.

Ball engineering

The ball houses many of the major vacuum cleaner components: motor, polycarbonate air ducts and cable. This lowers the centre of gravity, making the machine easy to control.

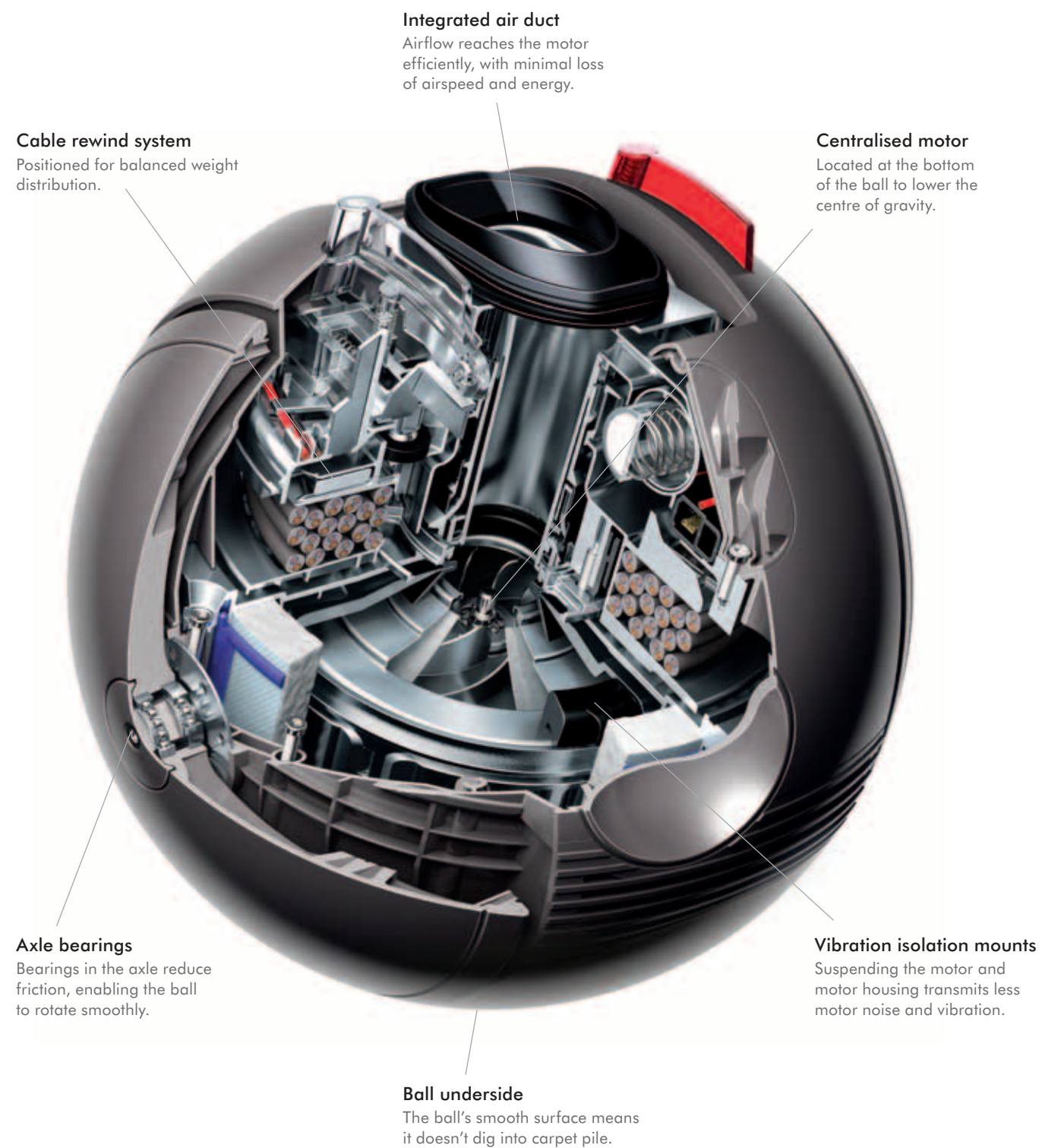

DC
39

Engineered to remove more dirt.
Follows without the awkward moves.

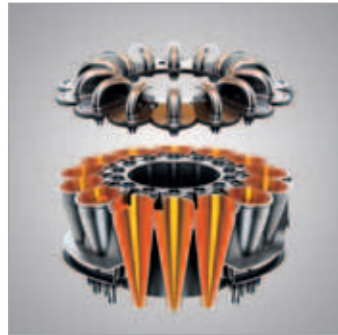

Captures more dirt than any other cyclone

Radial Cyclone™ technology has remodelled airflows to maximise suction.

Also included:

Combination accessory tool

Reaches further and has softer bristles for improved spot cleaning and gentle dusting.



Stair tool

Removes dirt and dust from corners and against vertical edges of stairs.



No ongoing costs

Other machines are still designed to need replacement bags or filters.



Approved by the National Asthma Council Australia.

Suction release trigger

Reduces suction so you can clean curtains, upholstery or rugs without them sticking to the cleaner.

Swivel cuff

Prevents hose from twisting during use.

Captures allergens, expels cleaner air

Dyson cyclones can capture particles down to 0.5 microns – including pollen, mould and bacteria.

Lifetime HEPA filter

For allergy sufferers. Captures pollen, bacteria and mould spores.

Tough, durable construction

Made from the strongest materials available to withstand bumps.

Lightweight adjustable wand

Adjust to the length you need.

Low hose connection point

Keeping the applied force closer to the ground increases stability when pulled.

Ball™ technology

Turns on the spot. The only barrel vacuum cleaner with a central steering mechanism – for greater control.

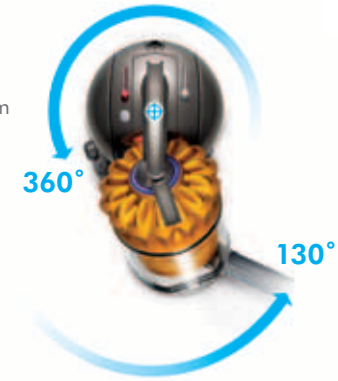

Detachable handle

Attach tools directly, to clean awkward places.

Clear bin

Made from tough polycarbonate. Lets you see when it needs emptying.

Hygienic bin emptying

Just push the button, no need to touch the dirt.

Articulating cyclone pack

The cyclone pack articulates with the chassis, so it's easy to control when moving around obstacles.

Smooth cable rewind

Cable rewind system has increased torque, so it's faster and less likely to catch on obstacles.

Axle bearings

Bearings in the axle reduce friction, enabling the ball to rotate smoothly.

Flexible cuff

Acts as a shock-absorber – re-aligning the machine to keep it on course when pulled.

Low centre of gravity

The balanced arrangement and low motor position provide a low centre of gravity – maximising stability.

Ball underside

The ball's smooth surface means it doesn't dig into carpet pile.

Follows with greater control

Wheeled vacuum cleaners can be awkward – heavy to pull, head the wrong way and collide with obstacles.

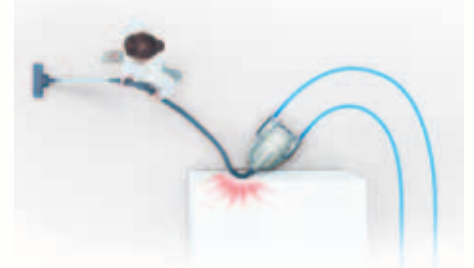

A Dyson Ball™ vacuum cleans without the awkward moves.



Cleaner head technology

Musclehead™ tool

Self-adjusts across all floor types.
Low profile for cleaning under furniture.



Self-adjusts for hard floors

On hard floors, the Musclehead™ tool brushes stay in contact with the floor removing debris from the surface.



Self-adjusts for carpets

When the head moves across carpet, the pile agitates the surface recognition switch. This lifts the brushes, exposing the carpet to the dual channel edges that remove dirt trapped within the weave.

Triggerhead tool

The only turbine head activated at the handle. No more bending down.



Pressure Trigger

Creates a drop in pressure which switches the turbine head on and off. No wires, no electronics.



Air switch

Activated by a change in air pressure, this switches the brush bar on and off.

DC 39 multi floor



Cleans every floor type.



Musclehead™ tool

Self-adjusts to maintain contact with the floor for a quicker clean. Switches easily between carpet and hard floors.

DC 39 allergy



For high performance on carpets and mattresses. Ideal for people with asthma and allergies.



Mattress tool

Removes dirt and dust mite faeces from mattresses and upholstery.

Triggerhead tool

For high dirt and pet hair pick-up from carpets. Brush bar can be turned off at the handle for delicate rugs and hard floors.

DC 39 animal



Powerful all-round pet hair removal. High performance on carpets, hard floors and upholstery.



Swivel hard floor tool

For high pick-up on hard floors.

Triggerhead tool

For high dirt and pet hair pick-up from carpets. Brush bar can be turned off at the handle for delicate rugs and hard floors.



Mini tangle-free turbine tool[^]

Counter-rotating heads with brushes remove hair and dirt.

[^]Available from April 2013 onwards.

DC 23 motorhead

Ideal for deep cleaning of carpets.



Radix Cyclone™ technology + intermediary cyclone

Doesn't lose suction. With an extra stage of separation to boost efficiency.

Easy steer motorised head

Motorised brush bar for best pet hair and dirt pick-up from carpets. Foot operated brush control turns the brush bar off to protect delicate rugs and hard floors.



Hard floor tool

With debris channel for high pick-up on hard floors.



Telescope Wrap™ system

Hose and wand compress and wrap for easier storage.



Approved by the National Asthma Council Australia.

DC 29 multi floor

Cleans every floor type.



Dual mode floor tool

For dirt pick-up on all floor types. Switches easily between carpets and hard floors.

Swivel cuff

Prevents hose from twisting during use.

Detachable handle

Click-fit tools directly to the end of the hose for cleaning confined spaces.

Captures allergens, expels cleaner air

Dyson cyclones can capture particles down to 0.5 microns – including pollen, mould and bacteria.

Hygienic one-touch bin emptying

Just push the button, no need to touch the dirt.

On-board tool storage

Brush, crevice and stair tools store on the machine so they're always on hand.

Sits on stairs

Designed to sit on stairs while you clean them.

Lifetime HEPA filter and Bactisafe™ screen

HEPA filter with Bactisafe™ screen traps and kills bacteria and mould on contact. Ideal for people with asthma and allergies.



Approved by the National Asthma Council Australia.

Radix Cyclone™ technology

Patented Dyson technology that doesn't lose suction as you vacuum.

Suction release trigger

Clean curtains, upholstery or rugs without them sticking to the cleaner.

Convenient tool storage

Combination accessory tool and stair tool store on the wand so they're always on hand.

Lightweight adjustable wand

Adjusts to the length you need.

Captures allergens, expels cleaner air

Dyson cyclones can capture particles down to 0.5 microns – including pollen, mould and bacteria.

Lifetime HEPA filter

Ideal for people with asthma and allergies.

dyson ball

No loss of suction.
No awkward moves.

Radial Cyclone™ technology
Remodelled airflows to maximise suction.

Ball™ technology
Turns on the spot with no awkward moves. It's easy to steer along edges and into awkward gaps.

Self-adjusting cleaner head
Brush bar height self-adjusts across all floor types. No fiddly dials or bending down to make adjustments.



Self-adjusting cleaner head

Many vacuum cleaners use fixed settings and don't adjust to different floor types – the bigger the gap, the more suction is wasted.

DC41 Animal, DC40 Allergy and DC50 Multi floor all have an active base plate. It creates the optimal cleaner head contact for every floor type, reducing air leaks and retaining suction.



How it works:

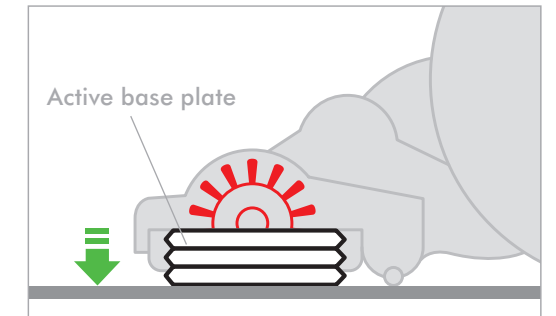

On hard floors

The base plate lowers to create an efficient seal. The brush bar lifts clear of the floor to protect delicate surfaces.

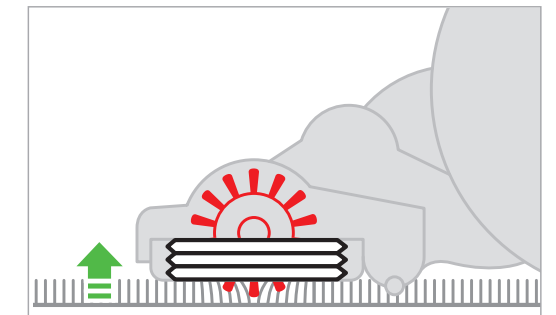

On carpet

The base plate rises and the brush bar lowers for optimum bristle penetration – removing ground-in dirt and hair from different depths of carpet pile.

Easy to use

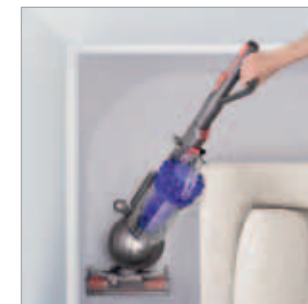

Turns on the spot

Ball™ technology steers smoothly. Allows easy access to awkward spaces.

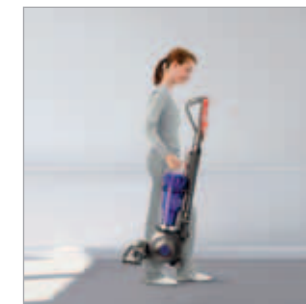

Durable

Engineered materials are selected for their strength and durability.



Instant release wand

Stretches up to 5 times in length for stairs and hard to reach places.



Hygienic one-touch bin emptying

Just push the button, no need to touch the dirt.

DC 41 animal

Powerful all-round pet hair removal. Easy to steer.
High performance on carpets, hard floors and upholstery.

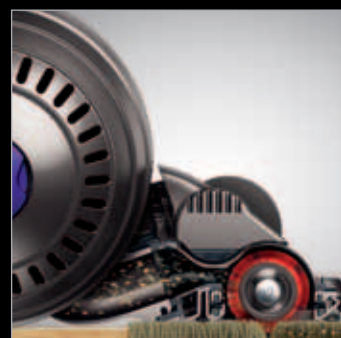

Captures more dirt than any other cyclone

Radial Cyclone™ technology has remodelled airflows to maximise suction.

Instant release wand

Stretches up to 5 times in length for stairs and hard to reach places.

Strongest suction at the cleaner head

Optimal cleaner head contact with every floor type, reducing air leaks for more suction.



Combination floor tool

For all floor types. Low reach to clean under beds and sofas.



Mini tangle-free turbine tool[^]

Counter-rotating heads with brushes remove hair and dirt.

Ball™ technology

Turns on the spot with no awkward moves. It's easy to steer closer to edges and into awkward gaps.

Pedal-free automatic recline mechanism

Simply recline and go.

Fingertip control

To instantly turn the motorised brush bar off for delicate rugs and hard floors.

Hygienic one-touch bin emptying

Just push the button, no need to touch the dirt.

Tough, durable construction

Engineered materials are selected for their strength and durability.

On-board tool storage

Combination accessory tool and stair tool are stored on the machine so they're always on hand.

Captures allergens, expels cleaner air

Dyson cyclones can capture particles down to 0.5 microns – including pollen, mould and bacteria.

HEPA filtration*

Ideal for allergy sufferers. Captures microscopic allergens as small as pollen and mould.

Self-adjusting cleaner head

Brush bar height self-adjusts across all floor types. No fiddly dials or bending down to make adjustments.



Approved by the National Asthma Council Australia.

[^] Available from April 2013 onwards.

* Whole machine HEPA filtration tested according to ASTM F1977.

DC 40 allergy

Steers into difficult places.
Ideal for people with asthma and allergies.

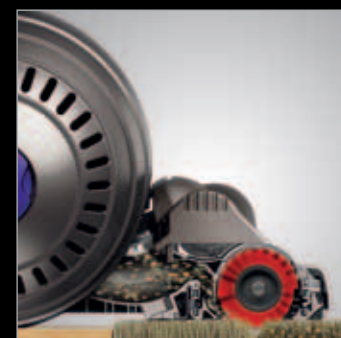

Captures more dirt than any other cyclone

Radial Cyclone™ technology has remodelled airflows to maximise suction.

Instant release wand

Stretches up to 5 times in length for stairs and hard to reach places.

Self-adjusting cleaner head

Optimal cleaner head contact with every floor type, reducing air leaks for more suction.



Combination floor tool

For all floor types. Low reach to clean under beds and sofas.



Mattress tool

Removes dirt and dust mite faeces from mattresses and upholstery.

Fingertip control

To instantly turn the motorised brush bar off for delicate rugs and hard floors.

Hygienic one-touch bin emptying

Just push the button, no need to touch the dirt.

Lightweight and durable construction

Engineered materials are selected for their strength and durability. Less weight and bulk.

On-board tool storage

Combination accessory tool and stair tool are stored on the machine so they're always on hand.

Captures allergens, expels cleaner air

Dyson cyclones can capture particles down to 0.5 microns – including pollen, mould and bacteria.

HEPA filtration*

Ideal for allergy sufferers. Captures microscopic allergens as small as pollen and mould.

Ball™ technology

Turns on the spot with no awkward moves. It's easy to steer closer to edges and into awkward gaps.



Approved by the National Asthma Council Australia.

* Whole machine HEPA filtration tested according to ASTM F1977.

DC 33 multi floor

Cleans every floor type.



Brush control

Lets you switch the brush bar off to protect delicate rugs and hard floors.



Combination floor tool

Switches easily between carpets and hard floors. Low reach to clean under beds and sofas.



Telescope Reach™ wand

Telescope wand for stairs and high reach cleaning.

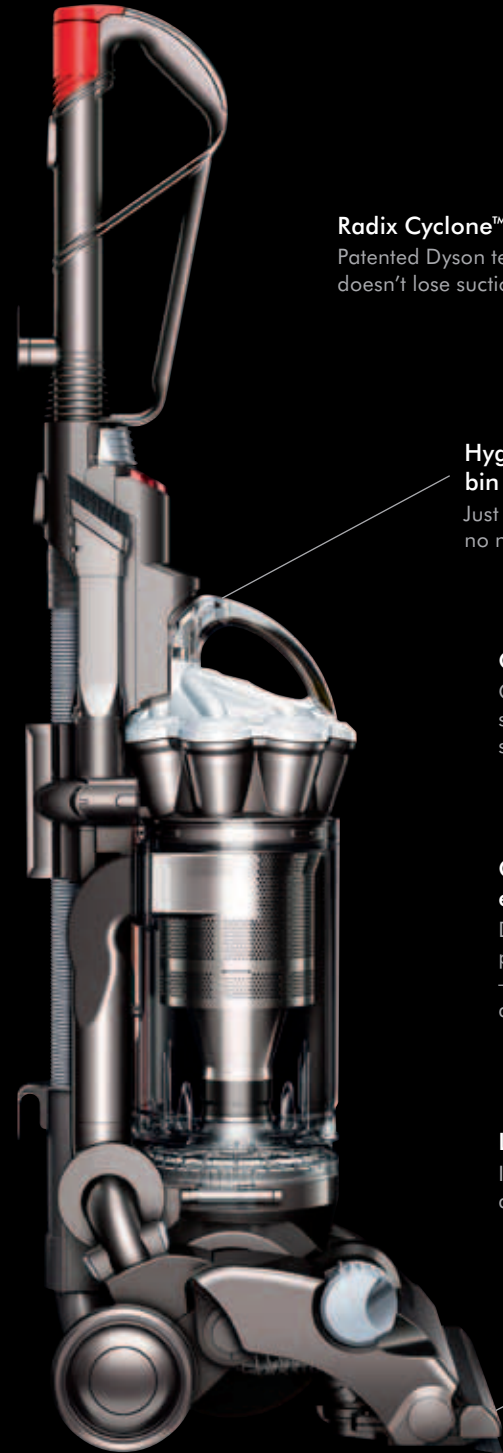

Radix Cyclone™ technology

Patented Dyson technology that doesn't lose suction as you vacuum.

Hygienic one-touch bin emptying

Just push the button, no need to touch the dirt.

On-board tool storage

Combination accessory tool and stair tool are stored on the machine so they're always on hand.

Captures allergens, expels cleaner air

Dyson cyclones can capture particles down to 0.5 microns – including pollen, mould and bacteria.

Lifetime HEPA filter

Ideal for people with asthma and allergies.

Auto carpet height adjustment

No awkward dials to adjust.

Forget conventional cleaning



Approved by the National Asthma Council Australia.

dyson digital slim Mk2

The cordless vacuum cleaner that doesn't lose suction.

DC 44 animal

Engineered for tough tasks. Captures hair and ground-in dirt.



Also available in blue



Powered by Dyson digital motor

Up to 3 times faster than conventional motors. The most power-efficient cordless vacuum cleaner.



No loss of suction

Patented Radix Cyclone™ technology and fade-free battery power for high constant suction.

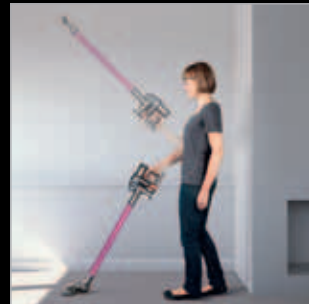

Balanced for floor to ceiling cleaning

Centre of gravity located towards the grip for easy handling up top, down below and in-between.



Double the power

100% more cleaner head power to drive bristles deeper into the carpet with more force.



Conventional cleaner heads

The problem with most conventional cleaner heads is that they can leave fine dust on hard floors.

Dyson motorised head with carbon fibre filaments

Carbon fibre filaments reduce static build up, removing fine dust from hard floors.



Docking station

Recharges and stores the machine and 2 attachments when not in use.

Remote charging

Battery can be recharged away from the machine and the docking station. Light indicates when fully charged.

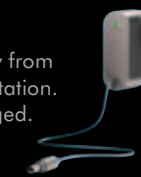

Stair and car cleaning

Floor tools and accessories attach directly to the machine.



Boost mode

Push button to select 8 minutes of high suction for more difficult tasks.



Increased run time

20 minutes of high constant suction.



Powered by an ENERGY STAR qualified battery charger for a better environment.

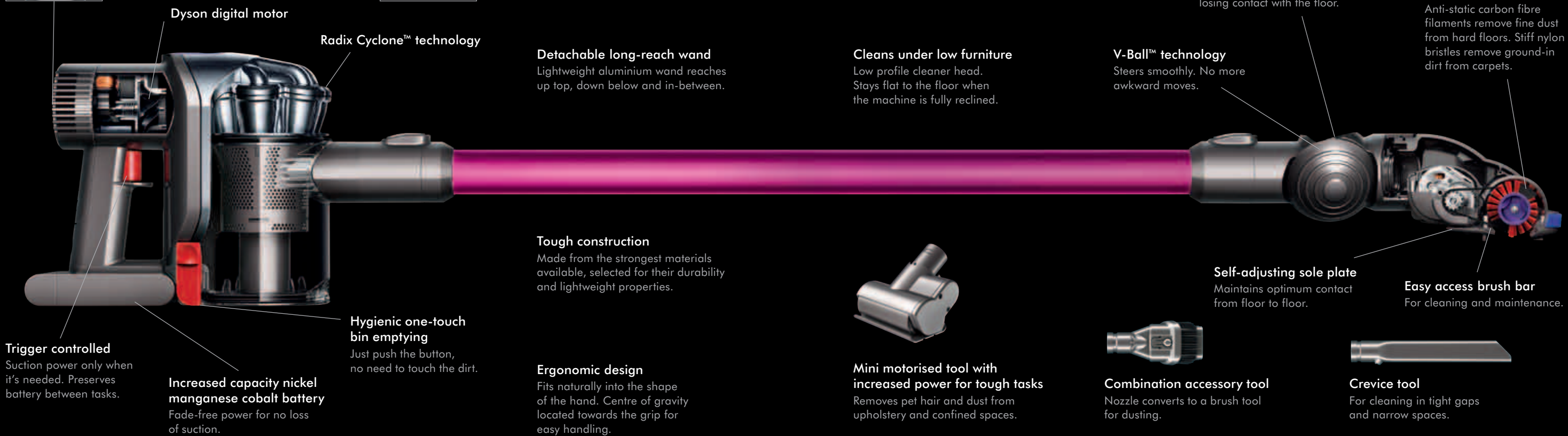

Dyson digital motor

Radix Cyclone™ technology

Detachable long-reach wand

Lightweight aluminium wand reaches up top, down below and in-between.

Cleans under low furniture

Low profile cleaner head. Stays flat to the floor when the machine is fully reclined.

Pivots for easier steering

Cleaner head pivots 180° without losing contact with the floor.

V-Ball™ technology

Steers smoothly. No more awkward moves.

Carbon fibre filaments

Anti-static carbon fibre filaments remove fine dust from hard floors. Stiff nylon bristles remove ground-in dirt from carpets.

Trigger controlled

Suction power only when it's needed. Preserves battery between tasks.

Increased capacity nickel manganese cobalt battery

Fade-free power for no loss of suction.

Hygienic one-touch bin emptying

Just push the button, no need to touch the dirt.

Tough construction

Made from the strongest materials available, selected for their durability and lightweight properties.

Ergonomic design

Fits naturally into the shape of the hand. Centre of gravity located towards the grip for easy handling.



Mini motorised tool with increased power for tough tasks

Removes pet hair and dust from upholstery and confined spaces.



Combination accessory tool

Nozzle converts to a brush tool for dusting.



Crevice tool

For cleaning in tight gaps and narrow spaces.

dyson digital slim

The cordless vacuum cleaner that doesn't lose suction.



Powered by Dyson digital motor
Up to 3 times faster than conventional motors. The most power-efficient cordless vacuum cleaner.



No loss of suction
Patented Radix Cyclone™ technology and fade-free battery power for high constant suction.

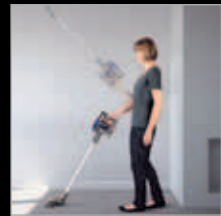

Balanced for floor to ceiling cleaning
Centre of gravity located towards the grip for easy handling up top, down below and in-between.

15 minutes

Run time
Up to 15 minutes of high constant suction.
(13 minutes with motorised floor tool/s attached)

Boost mode
Push button to select 6 minutes of high suction for more difficult tasks.

Lithium-ion battery
Improved energy density for a longer run time. Releases charge evenly for high constant suction.

Dyson digital motor

Radix Cyclone™ technology
Patented technology that doesn't lose suction as you vacuum.

Hygienic one-touch bin emptying
Just push the button, no need to touch the dirt.

Detachable long-reach wand
Lightweight aluminium wand reaches up top, down below and in-between.

Docking station
Recharges and stores the machine and 2 attachments when not in use.

Remote charging
Battery can be recharged away from the machine and the docking station.

Crevice tool
For cleaning in tight gaps and narrow spaces.

Combination accessory tool
Nozzle converts to a brush tool for dusting.

Pivots for easier steering
Cleaner head pivots 180° without losing contact with the floor. No more awkward moves.



DC 35 animal

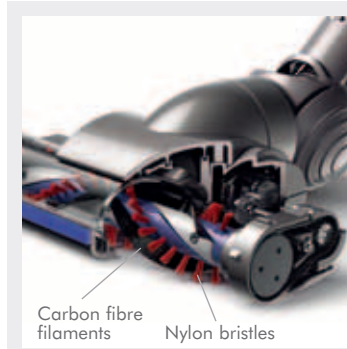

Motorised floor tool with carbon fibre filaments
Anti-static carbon fibre filaments clean hard floors. Rotating nylon bristles remove dirt from carpets.

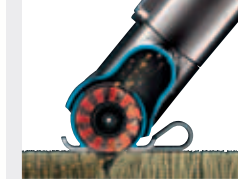

Mini motorised tool
Removes pet hair and dirt from carpets and upholstery in the home and car.



DC 35

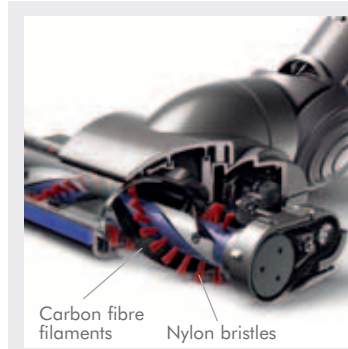

Motorised floor tool with carbon fibre filaments
Anti-static carbon fibre filaments clean hard floors. Rotating nylon bristles remove dirt from carpets.



The most powerful handheld



Tough construction

Made from the strongest materials available, selected for their durability and lightweight properties.

Lightweight and ergonomic

Balanced weight distribution for easy handling.

LED battery indicator

Indicates battery charge level and diagnostic status.

Radix Cyclone™ technology

Patented Dyson technology that doesn't lose suction as you vacuum.

Direct charging

Charger plugs directly into the battery – doesn't have to be attached to the machine.

Clear bin

Made from tough polycarbonate. Lets you see when it needs emptying.

15
minutes

Run time

Up to 15 minutes of high constant suction.
(13 minutes with motorised floor tool attached*).



Dyson digital motor

More powerful, using less energy than conventional motors. Creates the most power-efficient handheld.



Hygienic one-touch bin emptying

Just push the button, no need to touch the dirt.



Boost mode

Push button to select 6 minutes of high suction for more difficult tasks.



Up to 3 times faster recharging

Lithium-ion battery technology – recharges up to 3 times faster than others.

DC 34 animal

High performance spot cleaning on carpets and upholstery in the home and car.

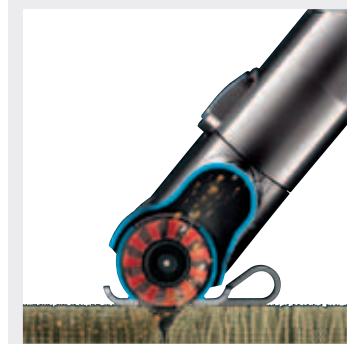

Mini motorised tool

Removes pet hair and dirt from carpets and upholstery in the home and car.

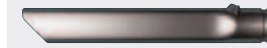

Crevice tool

For cleaning in tight gaps and narrow spaces.



Combination accessory tool

Nozzle converts to a brush tool for dusting.



DC 34

High performance spot cleaning in the home and car.



Crevice tool

For cleaning in tight gaps and narrow spaces.



Combination accessory tool

Nozzle converts to a brush tool for dusting.



*DC34 Animal only.

The only turbine tool that doesn't tangle.

Tangled



When hair wraps around the brush bar of conventional turbine tools, it slows them down or stops them working.

Tangle-free



The Mini tangle-free turbine tool uses counter-rotating heads with brushes to remove hair and dirt – without tangling.

Accessories

Dyson engineers have developed a range of tools to fit your Dyson vacuum cleaner. There's one for every kind of cleaning task.

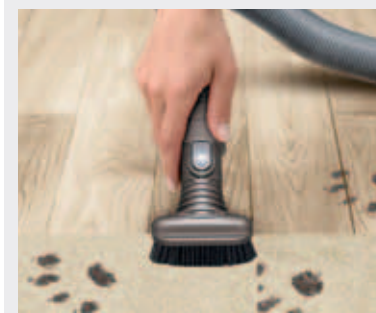

Stubborn dirt brush

Ideal for cleaning mud and dried-in dirt from floors and upholstery. Fits all models.

RRP: \$29

Part no. 918507



Mattress tool

Ideal for removing dirt and dust mite faeces from mattresses and upholstery. Fits all models.

RRP: \$29

Part no. 908940

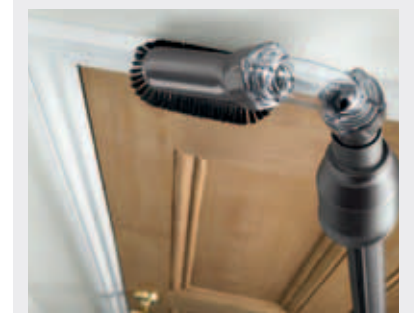

Up top tool

Twists to give multiple angles for cleaning hard to reach surfaces. Fits all models except handhelds.

RRP: \$49

Part no. 917645



Soft dusting brush

Ideal for cleaning blinds and dusting around the home. Fits all models.

RRP: \$49

Part no. 908877

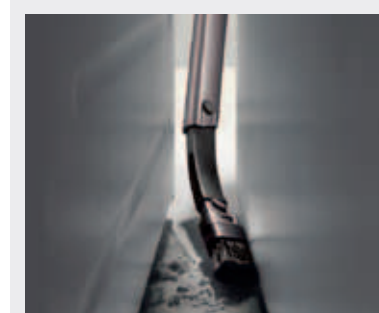

Flexi crevice tool

Extends and flexes into awkward gaps in the home or the car. Fits all models.

RRP: \$49

Part no. 908032



Groom tool

Self cleans. Mess-free vacuum assisted dog grooming. Fits all models except DC01 and cordless models. (If you have a barrel motorhead model please contact Dyson Customer Care).

RRP: \$89

Part no. 921000



Flat Out™ head

Super-low profile for easier cleaning under low furniture. Fits all models except cordless models.

RRP: \$49

Part no. 914606



Swivel hard floor tool

Ideal for pick-up on hard floors. Fits all models except DC01, DC21 Motorhead, DC23 Motorhead and cordless models.

RRP: \$59

Part no. 920018



Mini tangle-free turbine tool#

Ideal for picking up hair from stairs and upholstery. Fits all models from DC19 onwards except DC24 and cordless models.

RRP: \$89

Part no. 925067



Turbine head

For high dirt and pet hair pick-up from carpets. Fits all barrel models except DC02, DC05 Motorhead, DC08, DC19, DC22, DC26, DC38 and DC47.

RRP: \$129

Part no. 911566



Tool kit

Ideal for cleaning the car and around the home. Kit includes: Stubborn dirt brush, Mini soft dusting brush, Mattress tool and Extendable hose reaching up to 1.1m. Fits all cordless models.

RRP: \$99

Part no. 919648



Car cleaning kit

Three tools for a spotless car interior. Kit includes: Flexi crevice tool, Stubborn dirt brush and Mini tangle-free turbine tool#. Fits all models from DC19 onwards except DC24 and cordless models.

RRP: \$139

Part no. 908909

Mini tangle-free turbine tool available from April 2013 as an additional tool in DC39 Animal and DC41 Animal. Available as a standalone accessory from May 2013.

#Available from May 2013 onwards.

Dyson's recommended retail prices correct as at March 2013 but subject to change. Accessory colours may vary from pictures shown.

All Dyson vacuum cleaners feature:

- No loss of suction as you vacuum
- Dyson's patented cyclone technology
- Captures allergens, expels cleaner air
- No ongoing costs – lifetime filters
- Suitable for all floor types
- 2 year guarantee
- 7 days a week Helpline 1800 239 766

BARRELS						
	DC 23 motorhead	DC 39 animal	DC 39 allergy	DC 39 multi floor	DC 29 multi floor	DC 47 multi floor <small>NEW</small>
Product code	15425-01	22412-01	22411-01	22410-01	21960-01	25453-01
Main floor tool						
	Motorised head	Triggerhead tool	Triggerhead tool	Musclehead™ tool	Dual mode floor tool	Carbon fibre turbine head
Additional floor tool/s				Available at your local Dyson retailer and www.dyson.com.au the Dyson online shop		Available at your local Dyson retailer and www.dyson.com.au the Dyson online shop
	Hard floor tool	Swivel hard floor tool and Mini tangle-free turbine tool*	Mattress tool	Available at your local Dyson retailer and www.dyson.com.au the Dyson online shop		Available at your local Dyson retailer and www.dyson.com.au the Dyson online shop
Accessory tools	Brush, Crevice and Stair tools	Combination accessory tool and Stair tool	Combination accessory tool and Stair tool	Combination accessory tool and Stair tool	Combination accessory tool and Stair tool	Combination accessory tool and Stair tool
What will you be using your vacuum cleaner for?						
Main clean of your home	●	●	●	●	●	●
A quick tidy up in-between your main cleans						
Spot cleaning						
What size home do you have?						
Large – a family home	●	●	●	●	●	
Medium – a villa or apartment						●
Small – a studio or one bedroom flat						●
What performance do you need from your vacuum cleaner?						
High performance on carpets	●	●	●			
High performance on hard floors and tiles	●	●				●
A vacuum suitable for carpets and hard floors	●	●		●	●	●
If you have a dog or cat, what pet hair pick-up do you require?						
Best pet hair pick-up from carpets	●	●	●			
Improved pet hair removal from upholstery		●				
Ease of use						
Ball™ technology - easy to manoeuvre		●	●	●		●
High reach cleaning	●	●	●	●	●	●
Brush bar control at the handle		●	●			
Hygienic bin emptying	●	●	●	●	●	●
RRP**	\$1099	\$949	\$849	\$749	\$679	\$799

UPRIGHTS				
	DC 41 animal	DC 40 allergy	DC 50 multi floor <small>NEW</small>	DC 33 multi floor
Product code	20283-01	22909-01	24751-01	22075-01
Main floor tool				
	Self-adjusting motorised cleaner head	Self-adjusting motorised cleaner head	Self-adjusting motorised cleaner head with carbon fibre	Belt driven brush bar
Additional floor tool/s				
	Combination floor tool and Mini tangle-free turbine tool*	Combination floor tool and Mattress tool	Mini Flat Out™ head	Combination floor tool
Accessory tools	Combination accessory tool and Stair tool	Combination accessory tool and Stair tool	Combination accessory tool and Stair tool	Combination accessory tool and Stair tool
What will you be using your vacuum cleaner for?				
Main clean of your home	●	●	●	●
A quick tidy up in-between your main cleans				
Spot cleaning				
What size home do you have?				
Large – a family home	●	●		●
Medium – a villa or apartment		●	●	
Small – a studio or one bedroom flat			●	
What performance do you need from your vacuum cleaner?				
High performance on carpets	●	●		●
High performance on hard floors and tiles	●	●	●	●
A vacuum suitable for carpets and hard floors	●	●	●	●
If you have a dog or cat, what pet hair pick-up do you require?				
Best pet hair pick-up from carpets	●	●		●
Improved pet hair removal from upholstery	●			
Ease of use				
Ball™ technology - easy to manoeuvre	●	●	●	
High reach cleaning	●	●	●	●
Brush bar control at the handle	●	●	●	
Hygienic bin emptying	●	●	●	●
RRP**	\$949	\$849	\$749	\$679

HANDSTICKS				
	DC 44 animal <small>DOUBLE THE POWER</small>	DC 44 animal <small>DOUBLE THE POWER</small>	DC 35 animal	DC 35
Product code	24079-01	201119-01	22157-01	20561-01
Main floor tool				
	Carbon fibre motorised floor tool	Carbon fibre motorised floor tool	Carbon fibre motorised floor tool	Carbon fibre motorised floor tool
Additional floor tool/s				
	Mini motorised brush bar	Mini motorised brush bar	Mini motorised brush bar	Combination accessory tool and Crevice tool
Accessory tools	Combination accessory tool and Crevice tool	Combination accessory tool and Crevice tool	Combination accessory tool and Crevice tool	
What will you be using your vacuum cleaner for?				
Main clean of your home				
A quick tidy up in-between your main cleans	●	●	●	●
Spot cleaning	●	●	●	●
What size home do you have?				
Large – a family home				
Medium – a villa or apartment				
Small – a studio or one bedroom flat				
What performance do you need from your vacuum cleaner?				
High performance on carpets	●	●		●
High performance on hard floors and tiles	●	●	●	●
A vacuum suitable for carpets and hard floors	●	●	●	●
If you have a dog or cat, what pet hair pick-up do you require?				
Best pet hair pick-up from carpets				
Improved pet hair removal from upholstery	●	●	●	
Ease of use				
Ball™ technology - easy to manoeuvre				
High reach cleaning	●	●	●	●
Brush bar control at the handle				
Hygienic bin emptying	●	●	●	●
RRP**	\$549	\$549	\$499	\$469

HANDHELD		
	DC 34 animal	DC 34
Product code	21502-01	21499-01
Main floor tool		
	Mini motorised brush bar	Combination accessory tool
Additional floor tool/s		
	Combination accessory tool and Crevice tool	Crevice tool
Accessory tools		
What will you be using your vacuum cleaner for?		
Main clean of your home		
A quick tidy up in-between your main cleans		
Spot cleaning	●	●
What size home do you have?		
Large – a family home		
Medium – a villa or apartment		
Small – a studio or one bedroom flat		
What performance do you need from your vacuum cleaner?		
High performance on carpets	●	
High performance on hard floors and tiles	●	●
A vacuum suitable for carpets and hard floors	●	●
If you have a dog or cat, what pet hair pick-up do you require?		
Best pet hair pick-up from carpets	●	
Improved pet hair removal from upholstery	●	
Ease of use		
Ball™ technology - easy to manoeuvre		
High reach cleaning		
Brush bar control at the handle		
Hygienic bin emptying	●	●
RRP**	\$349	\$299

	Dual power mode for cordless models					
High constant suction	20 minutes	20 minutes	15 minutes	15 minutes	15 minutes	15 minutes
High constant suction with motorised head/s	20 minutes	20 minutes	13 minutes	13 minutes	13 minutes	
MAX power for more difficult tasks	8 minutes	8 minutes	6 minutes	6 minutes	6 minutes	6 minutes

***Available from April 2013 onwards.**
 **Dyson's recommended retail prices correct as at March 2013 but subject to change.

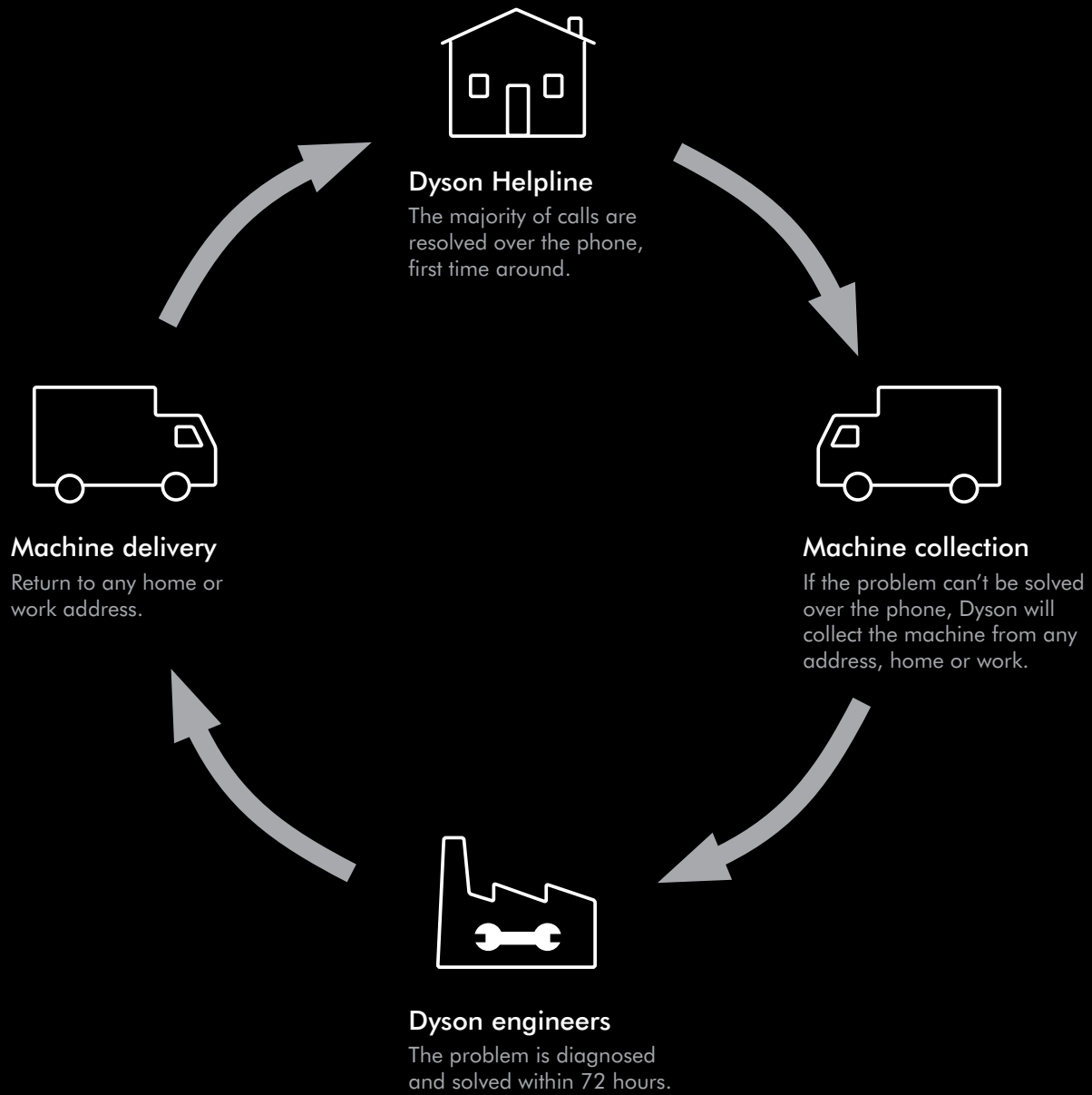

Australia's No.1 trusted brand
Vacuum Cleaners category

Dyson is committed to the highest standard of customer service. Every Dyson vacuum cleaner comes with a 2 year parts and labour guarantee. In the unlikely event of there being a problem, Dyson customer service centre will collect, repair and return the machine anywhere in Australia. They don't just solve problems though. You can get cleaning tips, advice about Dyson accessories or find out about new technology from Dyson.



1800 239 766 www.dyson.com.au

Monday – Friday 8:00am to 6:00pm EST

Saturday – Sunday 8:30am to 4:00pm EST



The vacuum cleaner that doesn't lose suction.