

dyson

User guide

Please read this user guide carefully before use.



This user guide also contains tips on effective washing and important safety notes.

contrarotator™

www.dyson.com



Contents

Overview	1 01	Overview of your Dyson Contrarotator™
Dyson Contrarotator™	2 01	The only 2-drum wash action
User Instructions	3 01	Free registration Important safety notes
Before installation	4 01	Inner transit packaging removal Moving the Contrarotator™
Installation	5 01	Specification Location Drainage, water supply and electricity
	02	Drainage Water supply
	03	Electrical installation After installation
Operation	6 01	Loading the Contrarotator™ Detergent use
Starting your wash	7 01	To start your wash, using default settings
Optional settings	8 01	To personalise the default wash programmes
Fabric care and Programme table	9 01	Fabric care
	02	Programme table
Maintenance	10 01	Cleaning
	02	Coin trap
	03	Water filter Emergency door release
Troubleshooting	11 01	Troubleshooting
	02	
	03	

Overview

1 01

Overview of your Dyson Contrarotator™

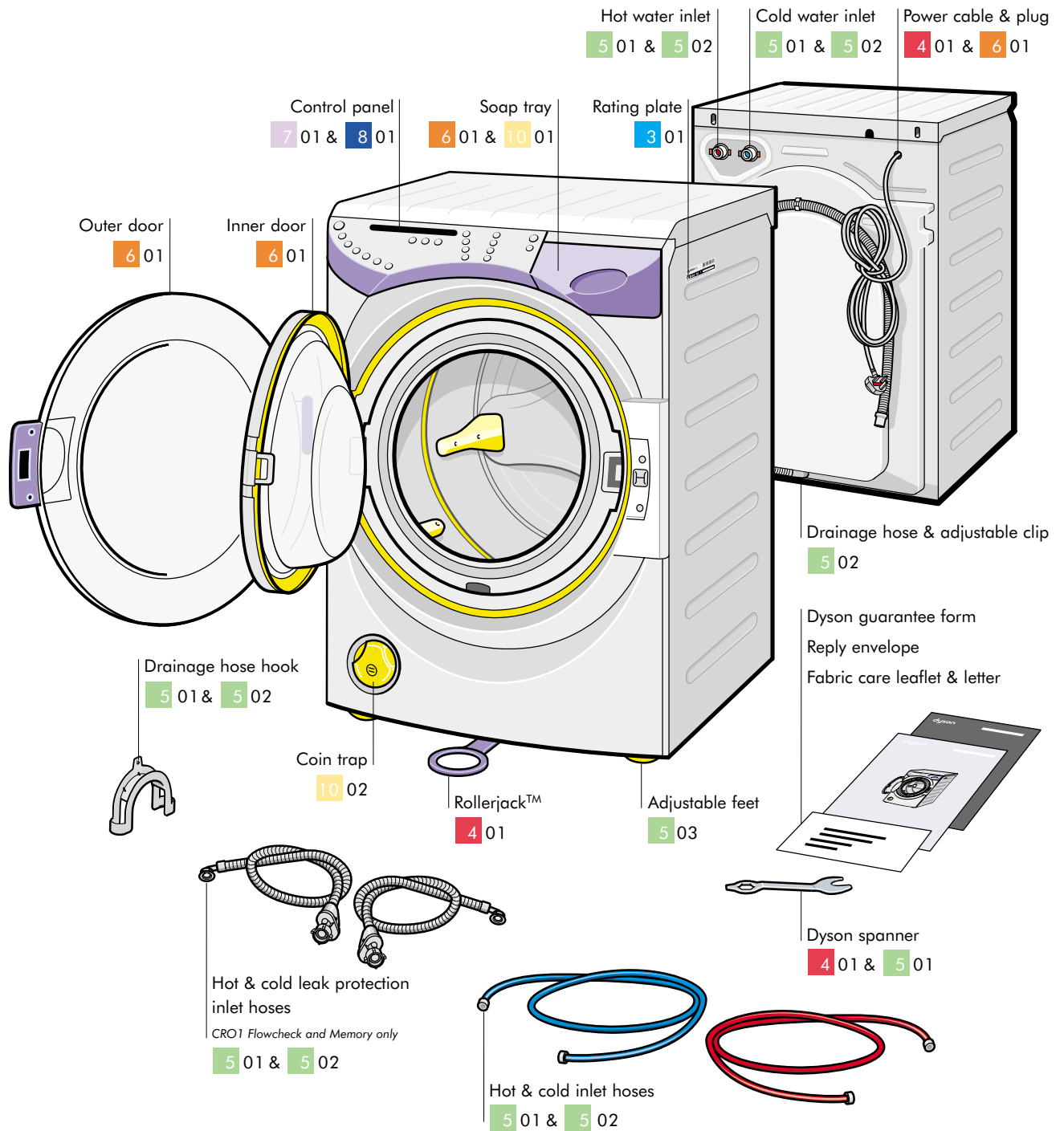

Dyson Contrarotator™

201

The only 2-drum wash action.

Conventional washing machines may seem convenient, but their poor performance lets you down. So James Dyson asked his engineers to experiment with every imaginable way of washing to design a better washing machine.

Along the way, Dyson engineers made a surprising discovery: washing by hand gave better wash results than single drum machines. Because the laundry is constantly on the move, it is manipulated and flexed. This opens the fabric to the detergent, releasing dirt quickly and effectively.

To replicate the movement of washing by hand, Dyson engineers designed two aligned drums and engineered them to rotate in opposite directions at the same time: laundry is constantly on the move, manipulated and flexed.

Because the Contrarotator™ releases dirt more effectively, it can wash laundry cleaner, faster and in larger loads.

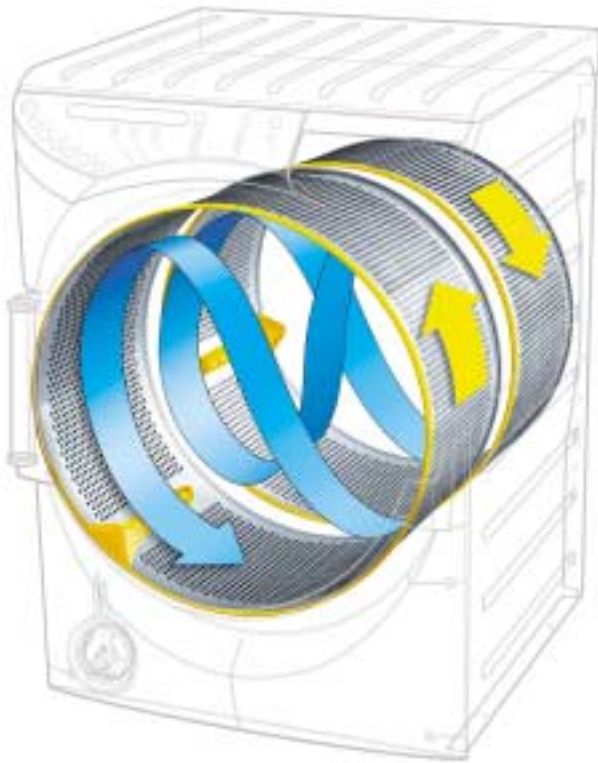

This product is protected by the following:

Patents and Patent Applications:

GB 00 01848.1	WO 01/71084	WO 01/73939	GB 2 337 274	WO 00/68490
GB 01 21535.9	WO 01/71085	WO 01/71083	US 6,311,527	PCT/GB01/02974
US 09/853,689	PCT/GB 01/03730	PCT/GB01/03716	EP 1078119	WO 99/58753
WO 01/71086	US 09/956,248	PCT/GB01/04324	JP 2000-548539	CA 2,332,024
WO 01/88256	WO 01/71087	US 09/956,163	US 09/853,689	AU 39393/99

Registered Designs:

GB 2090907	DE 40008214.4	FR 004914	AU 143433
CH 127265	IT MI 2000 O 000588	JP 1114510	US 29/128,794

Trade Marks:

DYSON™ CONTRAROTATOR™ DYSON CONTRAROTATOR™ CRO1™ ROLLERJACK™

Equivalent rights exist in other territories.

For patent information please see www.dyson.com

User Instructions

Free registration

Registering your Dyson Contrarotator™

Every Dyson washing machine comes with a complimentary 2 year guarantee, with an option to extend the guarantee for a further 1 to 3 years. For more details on these options, please refer to the enclosed guarantee form.

How to register

Please ensure that you register your guarantee as soon as possible. This can be done by:

- registering your machine at www.dyson.com
- or completing the enclosed guarantee card and returning it in the envelope provided.

(Please keep your proof of purchase in a safe place to ensure that you have this information available as it may be required in order for a service engineer to carry out a repair).

Dyson service

If a problem arises with your Dyson washing machine, or if it is displaying a fault code, please refer to the troubleshooting guide section 11 01 to 11 03.

If the problem is still not resolved, please:

- visit our website at www.dyson.com for on-line help
- or contact the helpline:

UK 0870 600 2701, 7 days a week (8am-8pm)

email service@dyson.com

ROI (01) 475 7109

email irelandservice@dyson.com

Serial number

For future reference, fill in your machine's details in the space provided. The serial number is on the rating plate (see section 1 01 for location).

Serial number

Date of purchase _____

Place of purchase _____

Important safety notes



Always:

- use the Rollerjack™ to move the machine. Care should be taken when moving it, as it is very heavy.
- turn off the machine with the 'Mains on/off' button and switch off at the socket when not in use.
- turn off the water supply to the machine and close both the inner and outer doors when not in use.
- close the soap tray before starting the machine.
- remove all items from pockets.



Do not:

- stack tumble dryers or other appliances on top of the washing machine.
- alter the machine or modify it in any way, as this will invalidate your guarantee and could be dangerous.
- carry out any maintenance work on the machine other than that outlined in this guide.
- use the washing machine if any part appears to be faulty, missing or damaged.
- overload the washing machine; the maximum loads are indicated in the programme table in section 9 02.
- use adapters or extension cables.
- use the washing machine for commercial or industrial purposes, as this will invalidate your guarantee. The machine is designed for domestic use.

Child safety

The Dyson Contrarotator™ has a child lock option. See section 8 01 for usage instructions.



Always:

- use the 'child lock' when the machine is not in use.
- check the drums are empty before loading the machine.
- use the 'child lock' when running the machine, if children are present.
- keep all packaging out of the reach of children.



Do not:

- allow children to play with or use the machine.

Before installation

401

Inner transit packaging removal

Before installation, check the machine for damage. A qualified person should always carry out installation. All packaging must be removed before the machine is connected to power or water supplies.

- 1 Open the outer door and carefully lift out the foam inserts from the front of the inner door.

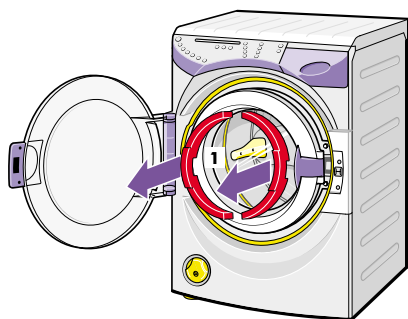

- 2 Take off the rear panel by removing the seven screws, using a cross-head screwdriver.
- 3 Carefully withdraw the foam block and then refit the rear panel and screws.
- 4 Remove the two screws from the rear of the lid.
- 5 Remove the lid by sliding it backwards and upwards.

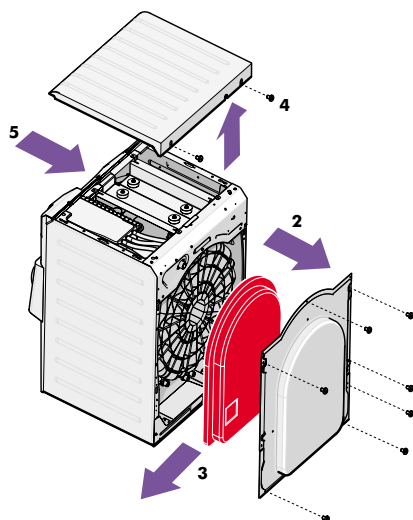

- 6 Remove the plug inserted into the transit bracket from inside the machine.
- 7 Using the Dyson spanner remove the four bolts securing the top transit bracket.

- 8 Remove the four screws securing the bracket to the machine casing and lift out the transit bracket.

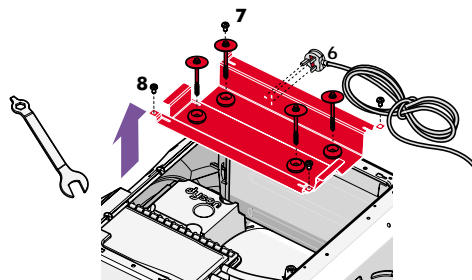

- Refit the lid and two screws. To replace the packaging (eg: for moving house), reverse the procedure described above. Please retain the transit packaging for future use, as it should be used whenever the machine is relocated.

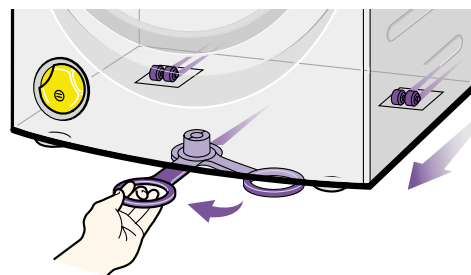

Moving the Contrarotator™

- To move the machine, pull out the Rollerjack™ handle from underneath the machine, which will enable you to manoeuvre the machine easily into your desired position.
- Replace the Rollerjack™ slowly because the handle may return with force.

NB: The Rollerjack™ is designed for final positioning only and not suitable over long distances. Do not push with your foot.

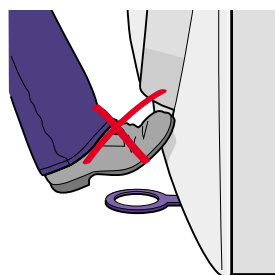

Installation

Specification

Dimensions: Height 848mm, depth 575mm, width 595mm

Weight: 103kg.

Voltage: 220-240V, 50Hz. Please refer to rating plate (see section 1 01 for location).

Power: 2750W (230V). Please refer to rating plate (see section 1 01 for location).

Water pressure: 0.4-5 bar.

Capacity: 7kg dry laundry (maximum).

Location

Every Dyson washing machine is tested before it leaves the factory. As a result, there may be some dampness or water in the machine.

- The machine should not be installed in a location where the temperature may drop below freezing.
- The machine should not be installed in a bathroom.
- The machine must be installed on a secure and flat surface. Soft floors, such as carpet or carpet tiles, are not suitable.

The layout of the drainage taps and power socket and their distance from the machine are illustrated below. The water inlet hoses, drainage hose and electrical mains lead must be positioned carefully to avoid damage or kinks when the machine is in use. The machine can be connected to a standpipe, under-sink pipe connection or other drainage system, but the critical dimensions must be adhered to.

Important

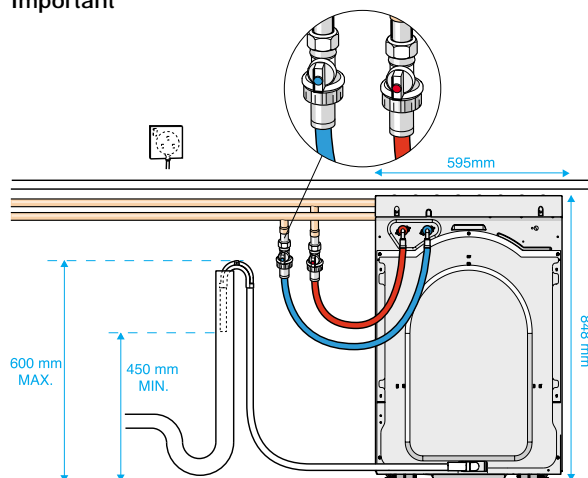

Drainage using a stand pipe*

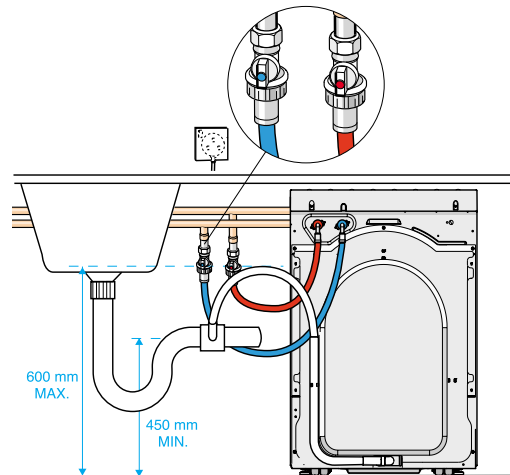

Drainage using a sink pipe*

Drainage, water supply and electricity

The washing machine comes with:

- 2 inlet hoses or
- 2 leak protection inlet hoses *CRO1 Flowcheck and Memory only*
- 1 drainage hose hook
- 1 Dyson spanner
- 1 drainage hose at the back of the machine

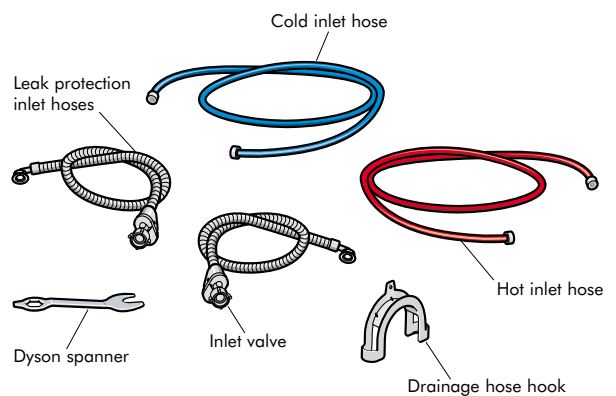

Note: CRO1 Flowcheck and Memory have grey leak protection inlet hoses

*All hoses can be supplied in 2.5m lengths if required. Please contact the helpline to order.

The above items are found in the drum unless stated otherwise.



NB: The leak protection hoses can be fitted to either supply, ensuring that the valve end is attached directly to the water mains. Take care not to cross the hoses eg: hot outlet to cold inlet.

Installation

Drainage

You can alter the direction of the drainage hose to the left or right.

- To change the direction of the machine's drainage hose, squeeze open the retaining clip using a pair of pliers and hold it open while you rotate the hose.
- Ensure the hose is inserted properly before releasing the clip.

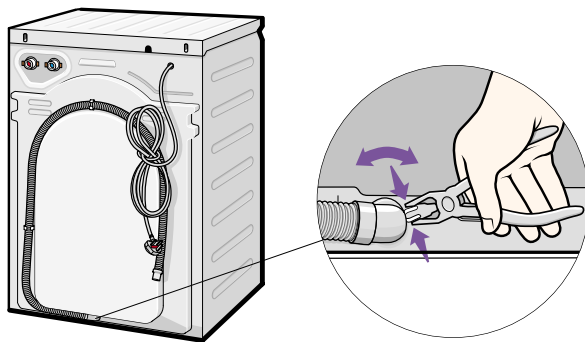

- Thread the drainage hose through the hose hook and adjust the protruding end to a distance of 30mm. The hose hook has a small retention hole that can be used to secure the hose in position.

⚠ Do not use the hose hook for under-sink connections.

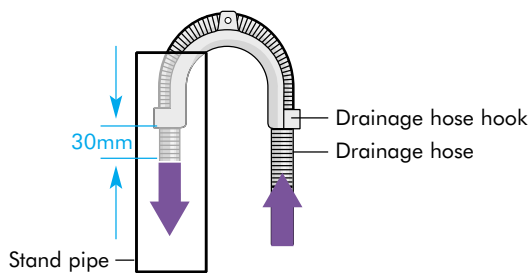

When installed with a standpipe or under-sink connection, ensure that the water outlet end of the drainage hose is no lower than 450mm above ground level. Position the hose so that none of it lies higher than 600mm above ground level (refer to section 5 01 for position).

⚠ NB: Failure to comply with these dimensions could cause the machine to malfunction.

Water supply

⚠ Always:

- connect your machine to the water supply by hand, using the hoses supplied. Do not tighten the plastic hose connections with a spanner. Do not use old hoses.

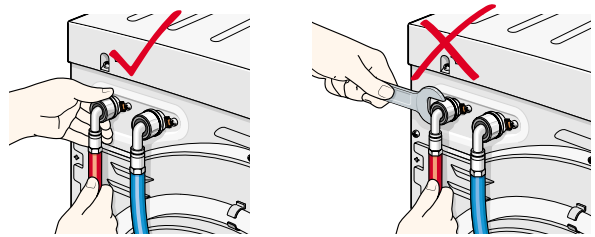

* Note: CRO1 Flowcheck and Memory have grey leak protection inlet hoses

- ensure the water pressure is between 0.4 and 5 bar.

⚠ Do not:

- connect the machine to a mixer tap.

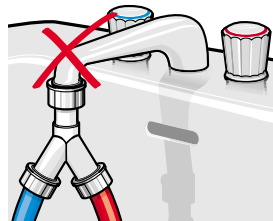

* Note: CRO1 Flowcheck and Memory have grey leak protection inlet hoses

Hot and cold water supply

- Attach the blue inlet hose/grey leak protection hose to the cold inlet tap and the red hose/other grey leak protection hose to the hot inlet tap, and turn on water supply.

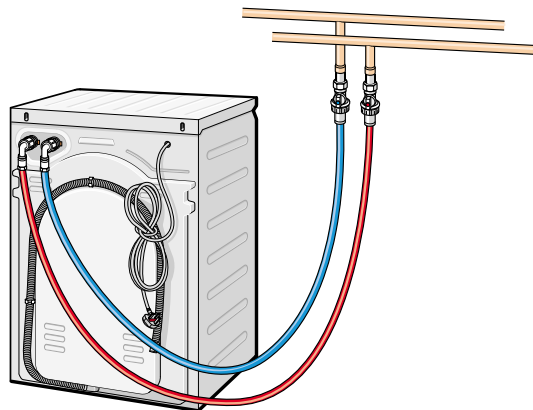

* Note: CRO1 Flowcheck and Memory have grey leak protection inlet hoses

Installation

5 03

Cold water only supply

- If there is no hot water supply, attach the cold and hot hoses to the machine as normal. Then, attach both hoses to a Y-piece (which can be ordered from the helpline) and finally connect the Y-piece to the cold inlet tap.

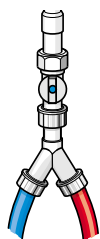

**Note: CRO1 Flowcheck and Memory have grey leak protection inlet hoses*

- Once all connections have been made, turn on the tap(s) to check that there are no leaks.

Electrical installation

Warning: This machine must be earthed

- Any electrical work required to install the washing machine should be carried out by a qualified electrician.
- Before using your machine, check that the plug and sockets match, and check that the voltage in your home corresponds to the machine's voltage. This information is on the rating plate (see section 1 01).
- The machine should be plugged into an earthed socket which can be switched on & off, and that is easily accessible after installation.
- Do not use an extension cord or plug adapter.
- If the supply cord or plug are damaged disconnect the machine from the socket outlet immediately. The supply cord must only be replaced by Dyson or its appointed agents, as special purpose tools and service techniques are required.
- If the plug supplied needs to be removed it should be cut off and safely disposed of. Under no circumstances should the severed plug be inserted into a socket outlet as this will present an electric shock hazard.

European conformity information

This Contrarotator™ has been tested and conforms to the following European Directives:
73/23/EEC Low Voltage Directive.
93/68/EEC CE Marking Directive.
89/336/EEC EMC Directive.

When all the instructions on the previous pages have been completed, the machine can be installed into its operating position using the Rollerjack™ handle (see section 4 01).

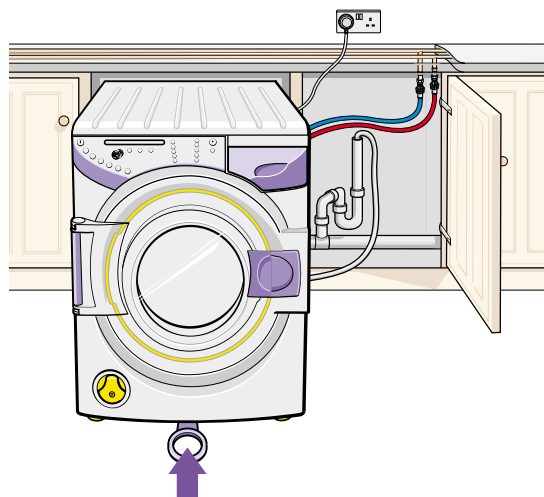

- Using the Dyson spanner, adjust the two front feet so that the machine is perfectly stable and will not rock on three of its four contact points.

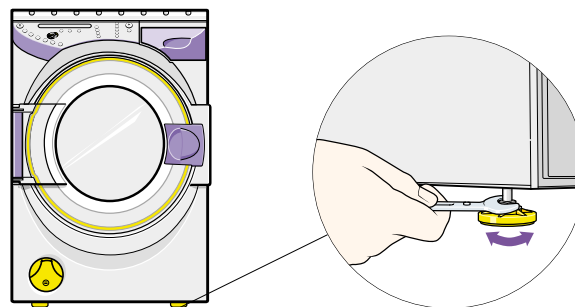

- Do not use wood, carpet or other material to stabilise the washing machine.

After installation

- Run an empty 60°C cotton cycle with a half measure of detergent. For the correct dosage, please follow the manufacturer's instructions on the detergent packaging. See sections 7 01 and 8 01 on how to start the machine.
- This will clean any test water out of the machine, and ensure the machine is installed and levelled correctly.
- Observe it regularly during the first wash and check connections afterwards and during the first week, to ensure that they have been fitted correctly.

Operation

Loading the Contrarotator™

- Plug the machine into the mains and switch on at the socket.
- Turn on the water supply at the mains.
- Open the outer and inner doors.
- Check the drums are empty before placing the sorted laundry into the washing machine.
- Close both doors, making sure that both have 'clicked' shut.

It is important not to overload the machine. Maximum loads for each programme are shown in the table section 9 02. Tests have shown that overloading can reduce the wash performance and may cause damage to your machine.

Detergent use

- To open the soap tray, press the hand  on the soap tray. Do not try to pull out the soap tray without first pressing it.

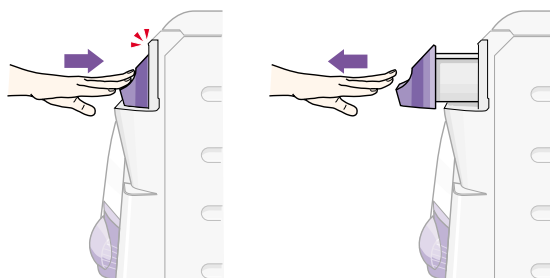

- Add detergent to the compartment marked 2 for all the main wash programmes.
- For a pre-wash option, add detergent to the compartment marked 1.
- Fabric conditioner can be added to the compartment marked  to the level indicated.

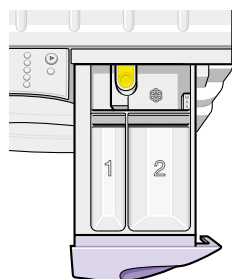

- Push the soap tray to close, ensuring it 'clicks'.

Detergent use

- Use only powder suitable for automatic washing machines.

Type of laundry	Type of detergent
Brightly coloured/multi coloured	Colour care
Whites	Conventional biological or non-biological
Wool, silk	Non biological wool/silk

Detergent format

Place wash balls and nets directly into the drums of the washing machine.





Do not:

- place wash balls or tablets in drums when using the start delay option (CRO1 Memory). This could fade coloured laundry if the detergent touches the fabric before the water soaks the laundry.
- place wash balls or tablets in drums when using a pre-wash. All the detergent will be used in the pre-wash, leaving none for the main wash. Use the soap tray instead.
- cover wash balls or tablets with laundry, as this can inhibit the dispersal of detergent.
- stop the wash for long periods of time once it has started. The detergent may not have had time to disperse and concentrations may damage the laundry.



Detergent quantity

- CRO1's drum capacity is 60% larger than other leading 'AAA' washing machines.
- This larger load will require a slight increase in detergent, as there will be more dirt circulating in the wash.
- When using your Dyson washing machine we recommend the following doses:

CRO1 with a half load

	Powder 1 scoop
	Liquid 1 dose
	Tablets 2 tablets

CRO1 with a full load

	Powder 1 1/2 scoops
	Liquid 1 1/2 doses
	Tablets 3 tablets

*For maximum dosage based on very heavy soil and hard water please refer to manufacturer's instructions on detergent pack.

Starting your wash

7 01

To start your wash cycle using the default settings

1

Switch on the machine



2

Select the programme

Select Cotton/Synthetics/Wool/Delicate/Handwash items or Duvet. Temperature, spin and soil type settings will automatically adjust to the default settings to give the best options for the selected wash. Please see section [8 01](#) for details of how to change the default settings.

3

Start your wash cycle

Press to start your chosen programme.

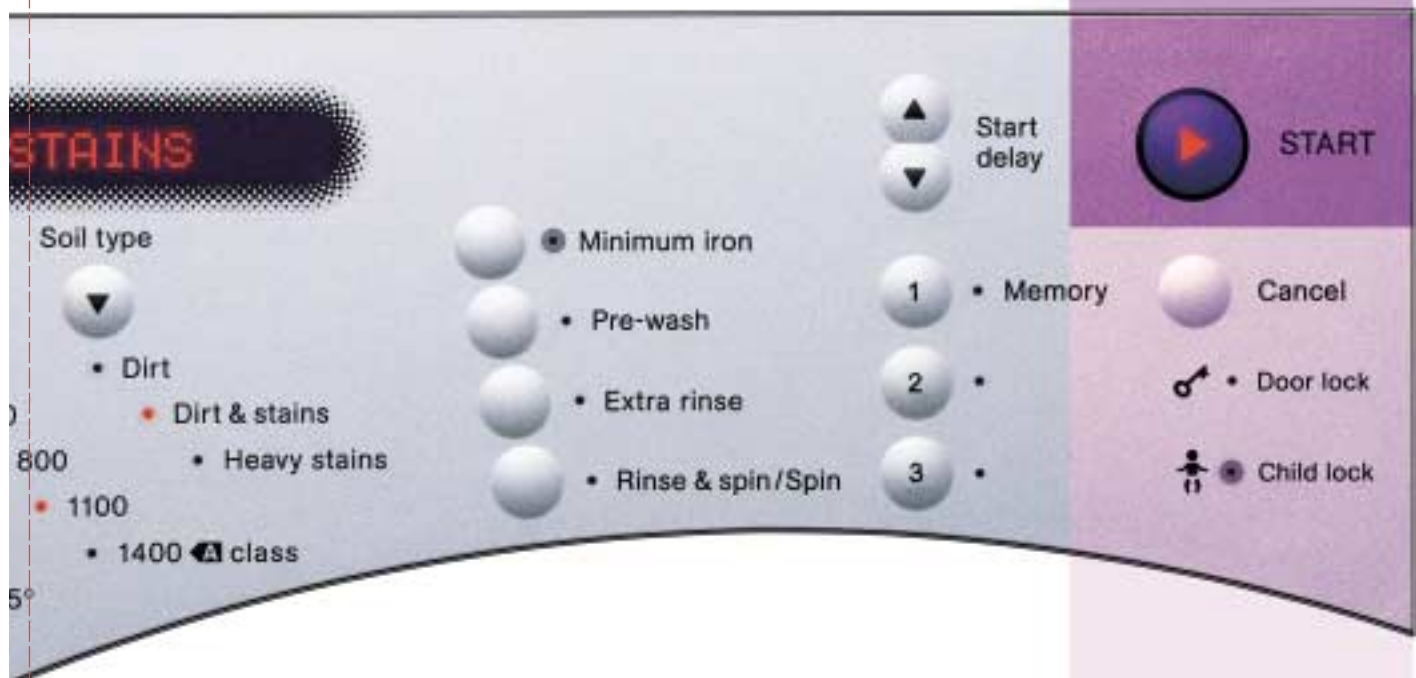

Pause your wash cycle

To pause the wash, press the 'Start' button (for example to add a forgotten item to the wash).

Press 'Start' once more to resume the wash. When a programme is paused, the door may remain locked for safety reasons (see section 8 01 for the door lock).

Cancel your wash cycle

To cancel the wash, press and hold down the 'Cancel' button. The outer door will unlock once the water has drained away, and if the inner door is cool enough (see section 8 01 for the door lock).

End of wash cycle

The display will show 'Programme finished' once the cycle is complete. Remove the washing and turn off the machine by pressing the 'Mains on/off' button.

Optional settings

8 01

To personalise the default wash programmes

Adjust your programme

After selecting the fabric type, press the temperature, spin and soil type buttons to scroll through the options and select your preferred settings. Note: on certain programmes some options are not available (see section 9 02).



Additional options

To activate any of the additional options below after you have selected your programme, press your desired option button once; press it again to cancel the option.

Start delay

only available on CRO1 Memory

This allows you to programme the wash to finish when you want it to. Use the ▲ and ▼ arrows to adjust the settings (eg: if you want the wash to start in 10 hours time, press the ▲ arrow 10 times) and press 'Start' to activate it.

The display will countdown the delay time to start. Press the 'Cancel' button at any time to cancel the wash.

Door lock

The door lock light indicates that the outer door is locked.

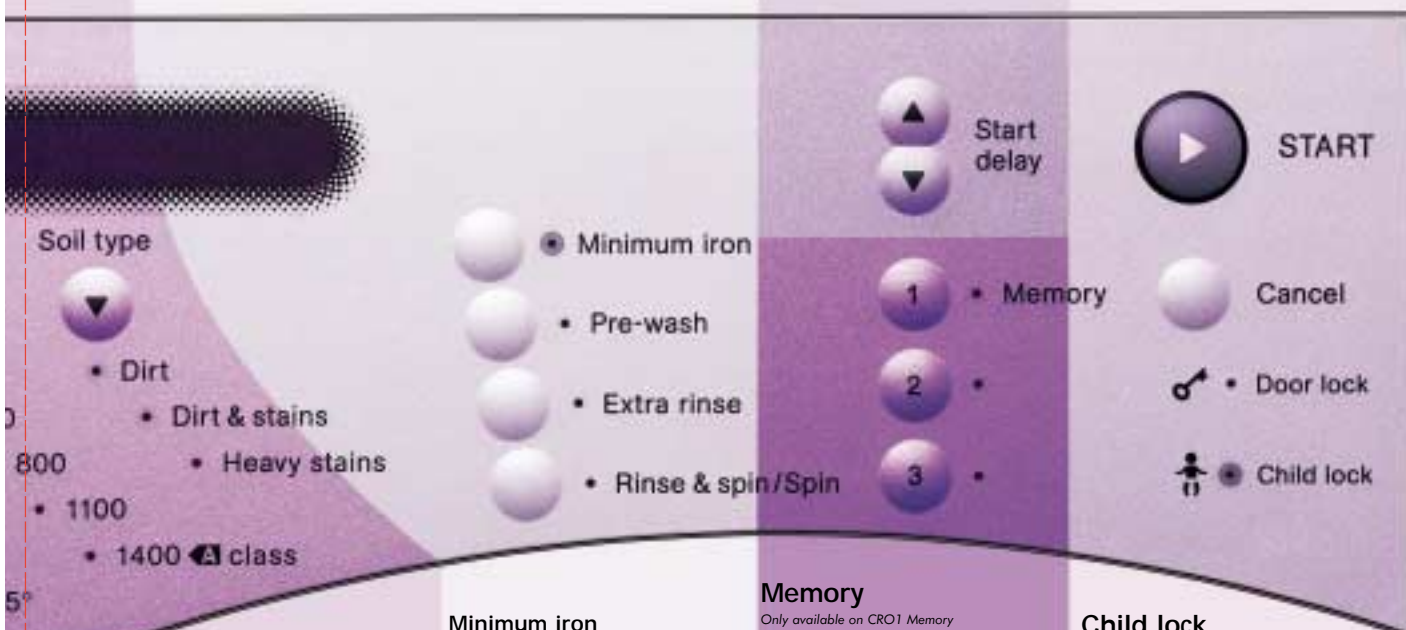

Soil type selection

Soil type can be adjusted on the Cotton and Synthetic programmes only, cleaning from everyday washing to heavily stained football kits.

Dirt

For lightly soiled laundry.

Dirt & stains

For typical everyday soiling.

Heavy stains

For heavily stained items. (see section 9 02).

Minimum iron

This holds your laundry in water after the final rinse to minimise creasing. To spin the laundry and finish the programme, press the 'Start' button. Minimum iron is not suitable on all programmes but is particularly good for synthetics and delicates.

(Please refer to section 9 02).

Pre-wash

This removes excess dirt before the main wash cycle.

Extra rinse

This adds one extra rinse for people with sensitive skin.

Rinse & spin/Spin only

Press once for 'Rinse & spin' option, press twice for 'Spin' only option and press a third time to cancel.

Memory

Only available on CRO1 Memory

This allows you to store the three programmes you use the most.

Select the programme with any additional options, then press and hold one of the memory buttons for one second. A beep will confirm the programme has been stored.

To select a stored programme, press the relevant 'Memory' button and then press 'Start'.

To re-programme a stored cycle, follow the steps for programming a memory cycle.

Child lock

This option locks the settings on the control panel and locks the outer door. Once a programme is running, use this option to prevent it from being altered, paused or cancelled. You can also use the Child lock when the machine is not in use to keep the outer door locked.

Press and hold the 'Minimum iron' button to activate and cancel the Child lock, before starting the cycle.













Fabric care and advice

9 01

Care symbol Washing process

Care symbol Washing process

Wash tips

	Cotton A wash tub with no bar underneath indicates the item is suitable for a high agitation wash. The maximum temperature is normally specified in the wash tub. <i>Suggested Dyson wash programme - Cotton</i>		Hot iron Iron 200°C
			Synthetics A wash tub with one bar underneath indicates the item is suitable for a medium agitation wash. The maximum temperature is normally specified in the wash tub. <i>Suggested Dyson wash programme - Synthetics</i>
	Wool/Delicate A wash tub with two bars underneath indicates the item is suitable for a gentle agitation wash. The maximum temperature is normally specified in the wash tub. <i>Suggested Dyson wash programme - Wool/Delicates. Note: Machine washable wool and wool mixes should only be washed on the Wool cycle.</i>		May be tumble dried Normal heat setting.
			Handwash Wash gently by hand or in a washing machine with a gentle handwash programme. <i>Suggested Dyson wash programme - Handwash items. Not all handwash items are suitable for a machine handwash programme. Check care label or contact garment manufacturer.</i>
	Do not wash Laundry with this symbol should not be put in a washing machine.		Do not tumble dry Tumble drying unsuitable laundry can result in shrinking and melting.
			
	Chlorine-based bleach may be used.		Do not dry clean
			
	Do not use bleach Use a colour care detergent for best results.		

Note: If in doubt of correct washing guidelines, please contact the garment manufacturer or retailer.



Always:

Care label

- check the wash care label on laundry to select the most appropriate programme. If you are unsure of the care label, use a gentle programme such as Wool.

Mixed fabric load

- wash a mixed load according to the most delicate item in it.
- sort laundry according to care label.

Sort laundry according to colours

- wash dark colours separately.
- wash new items separately for their first few washes as excess dye may run.

Wash bag

- place small items in a wash bag e.g. bras, stockings etc...

Prepare your laundry

- empty all pockets before loading the laundry into the machine, fasten zips, draw strings, tie belts and press studs before washing. Turn sleeping bags, duvet covers, jeans, knitted fabrics and coloured items inside out before washing, checking the wash care label.

Duvets

- check your duvet is machine washable.
- wash duvets on the Duvet cycle.
- refer to care label for wash temperature and drying recommendations.
- If the duvet is over 10.5 tog, we do not recommend spinning. If it is 10.5 tog or below, we recommend a maximum spin speed of 500 rpm.
- To load the duvet into the machine, feed the corner into the rear of the drum and continue to feed the duvet along its outer seam.
- CRO1 will wash most machine washable king size duvets up to 13.5 tog. Different manufacturers' duvet sizes can vary under the same tog rating.







Do not:

- wash frayed or torn fabrics.

Programme table

9 02

Care label	Suggested programme	Temperature	Spin speed	Soil type	Options	Maximum load	Cycle time
	Cotton Sturdy cottons Linen	30 – 60 °C	0 – 1400 rpm	Dirt For lightly soiled laundry	Pre-wash Extra rinse Rinse & spin/Spin	3.5 kg	40 mins*
		30 – 85 °C	0 – 1400 rpm	Dirt & stains For typical everyday soiling		7 kg	67 mins*
				Heavy stains For heavily stained items			85 mins*
	Synthetics Cotton mixes Mixed fibre Polycottons Fabrics with special finishes (eg: 'non-iron' treated cotton) Mixed fabric wash loads Printed cottons Polyester	30 – 50 °C	0 – 800 rpm	Dirt For lightly soiled laundry	Pre-wash Extra rinse Minimum iron Rinse & spin/Spin	4 kg	40 mins*
				Dirt & stains For typical everyday soiling			77 mins*
				Heavy stains For heavily stained items			85 mins*
	Delicates Micro fibres Synthetic laundry that require careful handling Printed fabrics Not for wool	30 – 40 °C	0 – 1100 rpm	No option	Pre-wash Extra rinse Minimum iron Rinse & spin/Spin	3 kg	77 mins*
	Wool Machine washable Wool and wool mixes	30 – 40 °C	0 – 800 rpm	No option	Extra rinse Rinse & spin/Spin	2 kg	45 mins*
	Handwash items Machine washable Handwash items only, requiring a very gentle action Washable silks	20 – 30 °C	0 – 500 rpm	No option	Extra rinse Rinse & spin/Spin	1.5 kg	45 mins*
	Duvet Please also read the duvet section in the 'Wash tips'	30 – 40 °C	0 – 800 rpm	No option	Pre-wash Extra rinse Rinse & spin/Spin		100 mins*

*Based on 40°C programmes and will vary according to temperature, hot/cold fill and options selected.

'AAA' Energy Label declaration is based on a Cotton, 60°C Dirt and Stains cycle. On some machines, cycle selections may differ from those shown.

Maintenance

10 01

Cleaning



Always:

- disconnect the machine from the mains before cleaning or carrying out any maintenance work.



Do not:

- clean the machine with cleaning solutions. Always use a clean, soft, damp cloth.

Cleaning the soap tray

- Remove the soap tray by pressing the yellow release button at the back of the tray, and pulling it out.

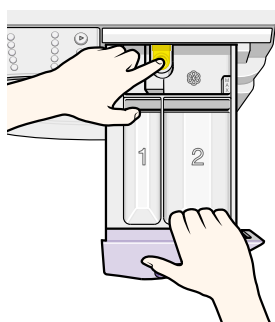

- Wash it in warm, soapy water with a small, soft brush, taking care not to scratch the soap tray front.

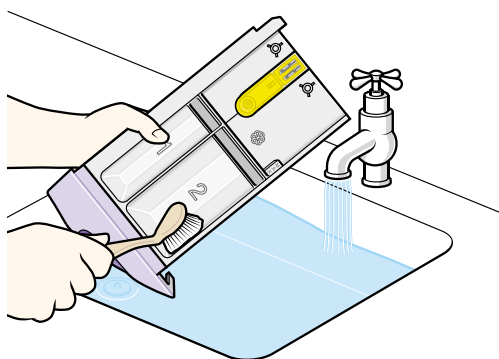

- The soap tray cavity in the machine should be cleaned out with a small, soft brush, taking care not to dislodge the rubber seal.



- Replace the soap tray ensuring it 'clicks' into place.



Do not:

- wash the soap tray in a dishwasher.

Maintenance wash

To prevent odours and build-up of deposits within the washing machine, it is recommended that you run an empty 85°C cotton cycle with a half measure of detergent 2 or 3 times a year.

If the outer door is dislodged from its safety hinge:

- 1 Locate the top ring of the outer door into the yellow part of the flexible safety hinge.
- 2 Lift the door and push it forward until the lower ring of the door 'clicks' into place.

The outer door is designed to 'pop' out of its hinge if leant on, however it is not designed to support a load.

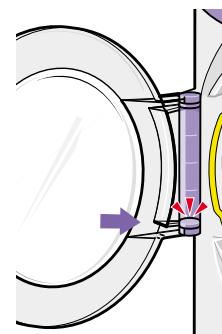
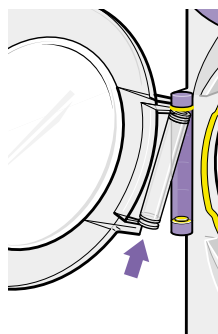

Maintenance

10 02

Coin trap

⚠ Never remove any objects from the coin trap while the washing machine is switched on, still running or paused during a wash. Always allow the water to cool before opening the coin trap.

- Empty the coin trap when a blockage has occurred.

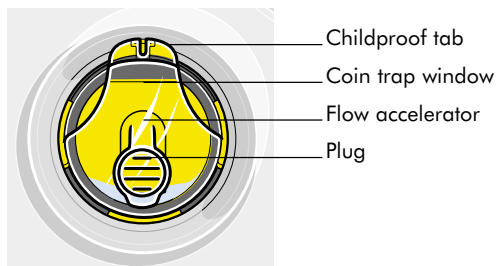

- 1 Place a tray or shallow dish underneath the coin trap.
- 2 Using the Dyson spanner, lever the plug in the middle of the coin trap. The water will drain from the plug.

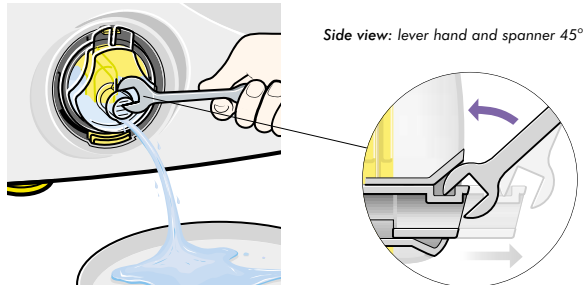

- 3 If the tray or dish is full, push the plug into its original position by hand, empty the tray or dish and repeat the process.
- 4 Once the water has been removed (a small quantity of water will remain below the level of the plug), lift the childproof tab using the Dyson spanner. Then turn the window anticlockwise until it is released.

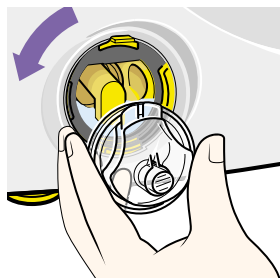

- 5 Remove any objects from the coin trap.

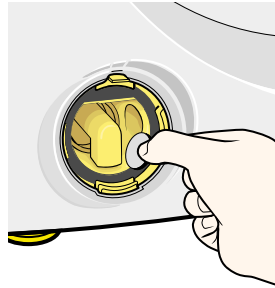

- 6 If any more items seem to be blocking the coin trap, pull out the flow accelerator.

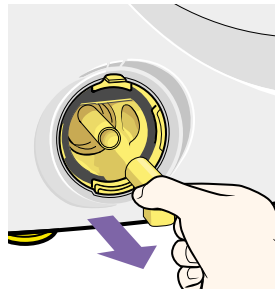

- Remove any items and firmly push the flow accelerator back into place.

To replace the coin trap cover:

- Ensuring the seal is in place, lubricate with a drop of washing up liquid.
- Fit the cover with the plug at the top.
- Turn 1½ turns clockwise, ensuring the childproof tab 'clicks' back into place.
- Make sure the plug is pushed back into the closed position.

Maintenance

10 03

Water filter

 To access the rear of the machine use the Rollerjack™ handle to pull the machine out (see section 4 01 for details).

Cleaning the water inlet filters

The water inlet filters should be checked regularly for debris or limescale build-up (particularly in a hard water area). Contact your local water authority to find out your water composition.

- Turn off the water supply to the machine.
- Unscrew both water inlet hoses by hand.
- Using pliers, grip the coloured filters, pull them out and rinse them under cold water.

NB: Some water may remain in the hoses.

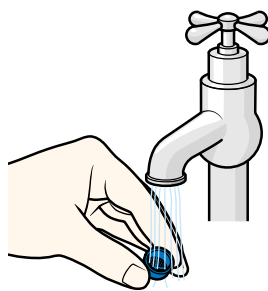
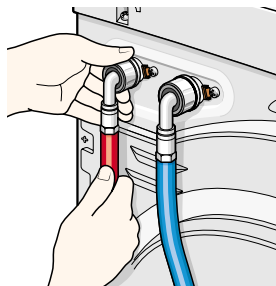

Note: CRO1 Flowcheck and Memory have grey leak protection inlet hoses

- Replace the filters, red to the hot fill and blue to the cold fill, and reconnect the water inlet hoses.

Emergency door release

 This should be used in the event of a power cut to remove laundry.

- Switch off and remove the plug from the socket.
- Ensure the drums have stopped moving.
- If the machine has been running on a hot wash, leave it to cool down.
- Completely drain the washing machine (see section 10 02 under 'coin trap').
- Remove the soap tray as described in section 10 01.
- Using the Dyson spanner or a coin, turn the door release screw $\frac{1}{4}$ of a turn anticlockwise to unlock the door, hold the screw in this position and open the outer door.

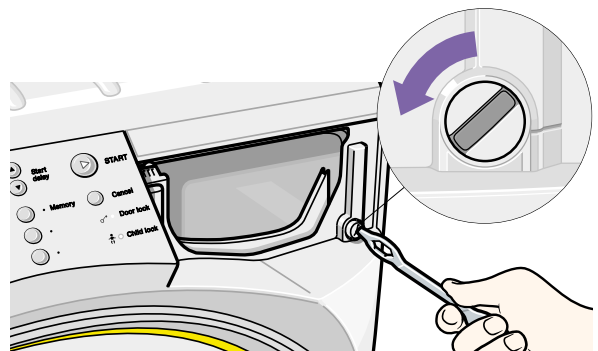

- Open inner door.
- Turn the door release screw clockwise through $\frac{1}{4}$ of a turn, to ensure the door will close. (This is automatic on some models).

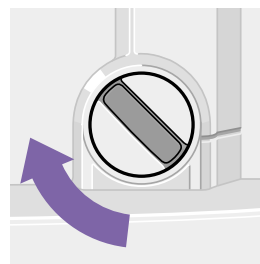

- Replace the soap tray.

Troubleshooting

11 01

 Before calling the helpline, please carefully read the following pages.

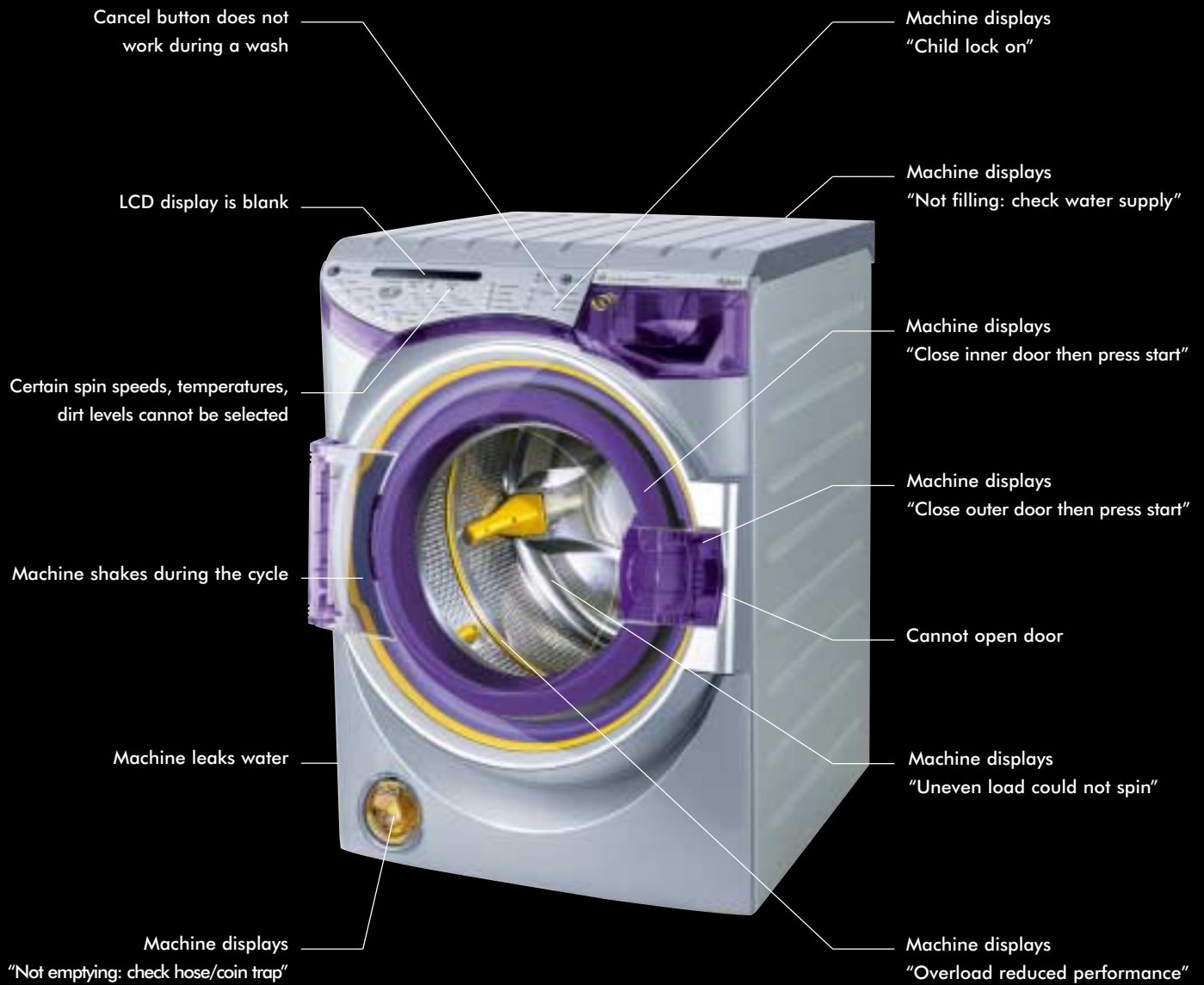

Troubleshooting

11 02

 Some solutions may require you to disconnect the electricity and water supply.

Symptom	Possible causes	Solutions
LCD display is blank	There is no power to the machine.	Ensure the machine is plugged in and switched on. Check the fuse and also that the circuit breaker has not tripped.
Certain spin speeds, temperatures or soil types cannot be selected	There are limits set on these options for each programme to prevent unsuitable options being selected.	See section 9 02 for the programme options wash table.
Cannot open outer door	Machine has not finished the cycle.	Wait for the machine to finish the cycle before opening the door. To cancel the wash hold down the 'Cancel' button.
	Machine has paused and the water level is too high or the water is too hot.	Press 'Start' to resume the wash.
	Child lock is active.	Hold down the 'Minimum iron' button until 'Child lock off' is shown on LCD.
	Power cut or any other cause not listed above.	Follow the 'Emergency door release' instructions in section 10 03 .
Machine leaks water	Coin trap cover is not in place, or the plug is not closed.	Turn off the water supply to the machine and ensure that the coin trap cover is correctly fitted and that the plug is closed, see section 10 02 .
	Machine is not level.	Adjust the feet until the machine is level, see section 5 03 .
	Drainage hose is not connected correctly.	Check the drainage hose is draining into a suitable place (drain, sink or standpipe), see section 5 02 .
	Inlet hoses are not positioned or correctly fitted.	Ensure the hoses are fitted correctly, see section 5 02 .
	Soap tray is open.	Close the soap tray.
Machine shakes during the cycle	2 adjustable front feet are not level.	Adjust feet until the machine is level, see section 5 03 .
	Rollerjack™ handle has not been replaced under the machine.	Return the Rollerjack™ handle carefully to its position under the machine, see section 4 01 .
Burning smell	Transit packaging not removed.	Remove top, rear and front packaging, see section 4 01 .
Clothes warm at end of cycle	Hot and cold pipes reversed.	Check orientation of hot and cold pipes.

Troubleshooting

11 03

LCD display message	Possible causes	Solutions
Child lock on	The child lock has not been deactivated.	Hold down the 'Minimum iron' button until 'Child lock off' is shown on the LCD.
Overload reduced performance	The recommended wash load has been exceeded or unusual items have been washed. The wash load is uneven.	In future, refer to the programme table section 9 02 or cease to wash the particular unusual item(s).
Uneven load could not spin	The machine sensed that spinning would be unsafe. Unusual items eg: trainers may have been washed.	Remove some items or reload the machine and select 'Spin only' option (see section 8 01).
Close outer door then press start	Outer door not closed properly, manual release still open.	Close the outer door, ensuring nothing is trapped. Turn manual release clockwise (see section 10 03).
Close inner door then press start	Inner door not closed properly.	Close the inner door, ensuring nothing is trapped.
Not emptying: check hose and coin trap	Coin trap blocked.	Remove blockages (see section 10 02).
	Machine full of suds.	Leave suds to settle. In future, refer to the manufacturer's dosage instructions.
	Drainage hose not draining.	Check that the drainage hose is installed according to the installation instructions (see sections 5 01 & 5 02).
Not filling: check water supply	Water supply is not connected.	Check that the water supply is connected and turned on at the tap.
	Filter is blocked.	Clean the filters (see section 10 03).
	Inlet hoses are blocked or kinked.	Unblock or straighten the inlet hoses.
	Drainage hose is installed incorrectly.	Unblock or straighten the drainage hose.
	Flood protection hose (Memory only)	Fitted back to front.
Fault	There is a technical fault with your washing machine.	<p>Contact the Dyson Helpline or visit the website www.dyson.com with the following information:</p> <ul style="list-style-type: none"> Your machine's serial number (see <i>side of machine</i>). Where and when you purchased your washing machine. Your address. The fault code that appears on the LCD display, if applicable. <p>A Dyson service engineer will visit you to test your machine and repair if necessary.</p>

www.dyson.com

Dyson Helpline

UK 0870 600 2701

email service@dyson.com

ROI (01) 475 7109

email irelandservice@dyson.com

NOTE: If an engineer is booked and it is found that the fault could have been rectified using troubleshooting guide, you may be charged.



UK 0870 600 2701
Open 7 days a week, 8am – 8pm
ROI (01) 475 7109

Dyson Ltd Tetbury Hill Malmesbury
Wiltshire SN16 ORP

www.dyson.com